

6050X1

OPERATING INSTRUCTIONS

TRASE SYSTEM I - For Soil Moisture Measurement - Version 2000 Software

1996

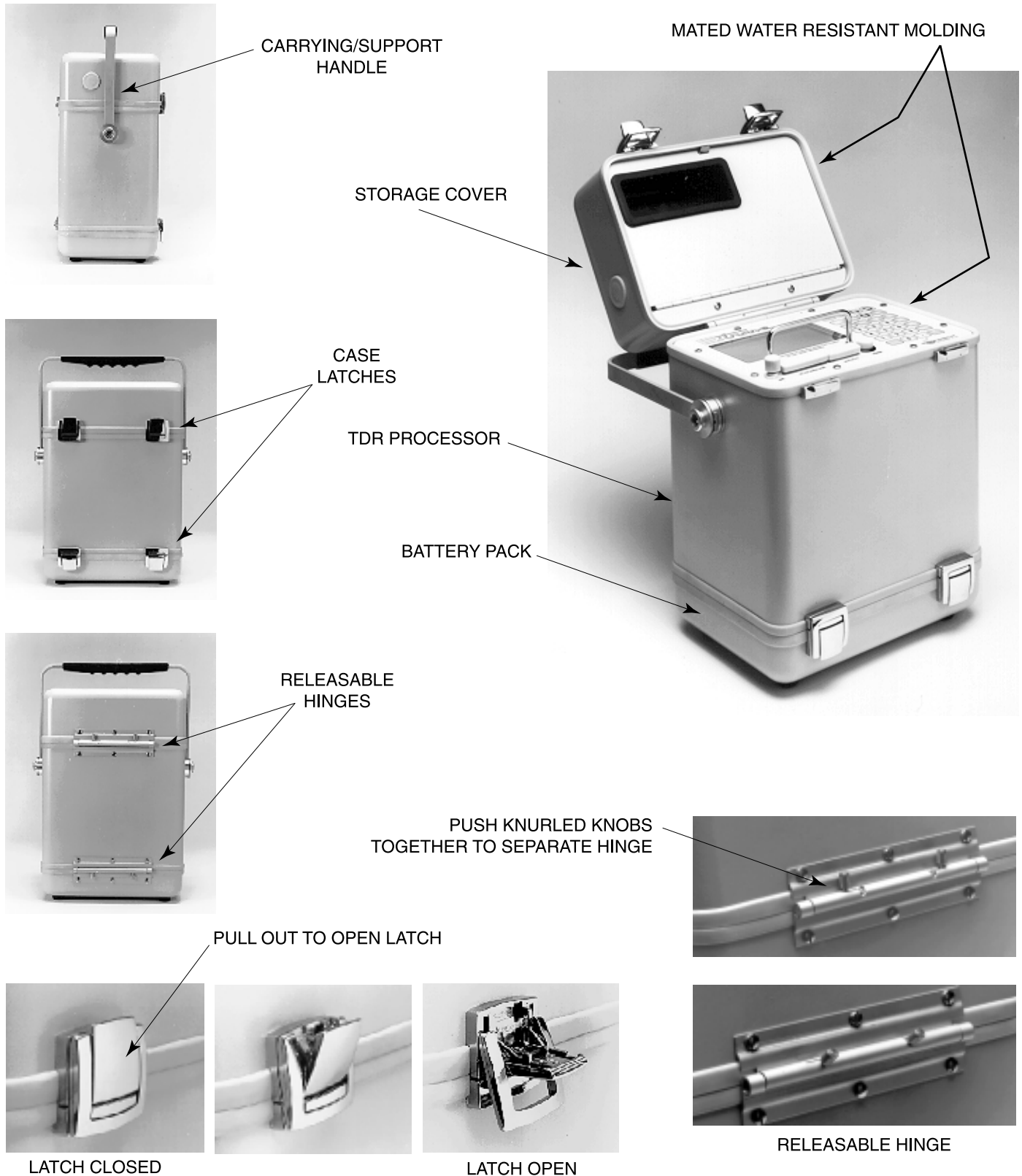

SOILMOISTURE EQUIPMENT CORP.
P.O. Box 30025, Santa Barbara, California 93105 USA
Phone: (805) 964-3525 · Fax: (805) 683-2189
e-mail: sales@soilmoisture.com · Web: <http://www.soilmoisture.com>



TABLE OF CONTENTS

1.	YOUR NEW TRASE SYSTEM.....	1-1
	Unpacking	1-1
	Cautions and Warnings	1-1
	Not Liable for Improper Use	1-1
	General Specifications	1-2
2.	PRINCIPLES AND TECHNIQUES OF OPERATION.....	2-1
	Theory	2-1
	The Measurement System	2-2
	The Capture Window	2-3
	The Meaning of Various Graph Features	2-4
	Determine Ka	2-6
	Relationship of Ka to Moisture Percentage	2-7
	Graphs on Relationship of Ka to Moisture Percentage	2-8
3.	ACQUAINT YOURSELF WITH THE PARTS	3-1
	Storage Cover and Contents.....	3-1
	Waveguide Connector and Waveguides	3-3
	Coaxial Cable Assembly	3-5
	Buriable Waveguide.....	3-6
	Battery Charger	3-6
	TDR Processor	3-7
	Housing	3-7
	Control Panel	3-9
	BNC Port	3-9
	RS-232 Serial Port	3-10
	Multiplex Port	3-10
	Power Port	3-11
	Base Panel	3-12
	Battery Pack.....	3-13
4.	REQUIREMENTS PRIOR TO USE	4-1
	Check Battery Charge/Charge Batteries	4-1
	Turn on Power Switch	4-2
5.	ACQUAINT YOURSELF WITH THE OPERATION OF THE CONTROL PANEL.....	5-1
	Activate the TDR Processor	5-1
	Review the Operational Screens	5-1
	Screens Available in the “Normal” Mode	5-2
	Screens Available in the “Shift” Mode	5-3
	Review Help Screens	5-4
	Operate the Cursor	5-5
	The Time Bars.....	5-5
	Enter Numerals	5-6

Enter Alpha Characters	5-6
Zero Set Key	5-7
Measure Key	5-7
Storing a Reading or Graph Keys	5-8
Erasing Stored Data Key	5-8
Sending Data Key	5-8
6. USING THE SETUP SCREEN	6-1
Call Up Screen	6-1
Set The Length Units	6-1
Set “Cable Loss” Value	6-1
Select The Moisture Table	6-2
Set The Date	6-2
Example	6-3
Set The Time	6-3
Example	6-3
Set the Capture Window	6-3
Select and Label The Storage Areas	6-4
Set Data Transfer Parameters	6-5
Modem	6-5
Set Auto Shutoff Time	6-5
Adjust LCD Contrast	6-5
Turn LCD Backlight On or Off	6-5
Help Screen	6-5
7. USING THE MEASURE SCREEN	7-1
Call Up Screen	7-1
Set the Waveguide Type	7-1
Set the Moisture Table	7-2
Making a Measurement with the Waveguide Connector	7-2
Zero Set	7-3
Mount Waveguides	7-3
Insert in Soil	7-3
Set Waveguide Length	7-4
Make a Measurement	7-4
“Tag” Reading	7-5
Store Reading	7-6
Use of Long Coaxial Cables and Cable Loss Settings	7-6
Making a Measurement with the Buriable Waveguides	7-7
Tag & Store Readings	7-8
Graphs Produced by Buriable Waveguides	7-9
Special Measuring Conditions	7-10
Measurements with Long Waveguides in Wet Soils	7-10
Measurements with Short Waveguides	7-10
Measurements in Saline Soils	7-10
Help Screen	7-10

8.	USING THE DATA SCREEN	8-1
	Call Up Screen	8-1
	Screen Abbreviations	8-1
	Scroll Through Data	8-3
	Retrieve Stored Data	8-3
	Erase Stored Data	8-4
	Use Cursor to Pick graph for Display	8-5
	Transfer Stored Data	8-5
	Message Symbols	8-5
	Help Screen	8-5
9.	USING THE GRAPH SCREEN	9-1
	Call Up Screen	9-1
	Select A Graph For Display	9-1
	Select From The Graph Screen	9-1
	Select From the Data Screens	9-2
	Review A Graph Before Storage	9-2
	“No Graph” Message	9-2
	Operate The Time Bars	9-2
	The Time Reference Grid	9-3
	Measure Time With The Time Bars	9-4
	Transfer Stored Graphs	9-5
	Help Screen	9-5
10.	USING THE AUTOLOG SCREEN	10-1
	Call Up Screen	10-1
	Set Starting Date	10-1
	Set Starting Time	10-2
	Set Cycle Interval	10-2
	Set Number Of Cycles	10-2
	The Trap Percentage Field	10-2
	Select Readings Or Graphs	10-3
	Prepare Connections For Series Of Reading Cycles	10-3
	To Abort The Autolog Cycle	10-3
	Apply The Sequence Switch	10-3
	Autologging With the Multiplexer	10-4
	Help Screen	10-4
11.	USING THE TDR SCREEN	11-1
	Call Up Screen	11-1
	Relationship of Time and Cable Length	11-2
	Setting the Start Time and Range	11-2
	Large Capture Window	11-3
	Small Capture Window	11-3
	Making a TDR Measurement	11-4
	Finding Cable Breaks	11-4
	Help Screen	11-5

12.	FIELD MEASUREMENTS.....	12-1
12A.	FIELD MEASUREMENTS USING THE STANDARD WAVEGUIDE CONNECTOR	12-1
	Insertion in Loose, Friable and Wet Soils	12-1
	Using Short Waveguides	12-1
	Using Long Waveguides	12-1
	Insertion in Dense Soils.....	12-3
	Repeat Readings At The Same Location	12-5
	Insertion In Containers	12-5
12B.	FIELD MEASUREMENTS USING BURIABLE WAVEGUIDES	12-6
	Installing Buriable Waveguides.....	12-6
	Precautions When Installing Buriable Waveguides	12-7
12C.	SEALING CONNECTING CABLES	12-8
13.	CUSTOM LOOKUP (MOISTURE) TABLES	13-1
	Standard Moisture Tables	13-1
	Custom Moisture Tables.....	13-1
	To Enter A Custom Moisture Table By Hand	13-1
	To Enter a Custom Moisture Table From A File	13-2
	Transfer a Moisture Table From Trase	13-3
14.	TECHNICAL INTERFACE INFORMATION	14-1
	Power Port Pin Assignment for Auxiliary Power	14-1
	Multiplex Port Pin Assignments	14-2
	Sequence Switch	14-2
	RS-232 Serial Port Pin Assignments	14-3
	... Setting Trase Communications Parameters	14-4
	... RS-232 Serial Port Cabling for Communications	14-5
	Cabling for PC/Trase Communication	14-5
	Trase Default Communications	14-6
	Direct Trase to PC Cabling (figure)	14-7
	Direct Trase to Serial Printer using Null Modem Cable or Straight Serial Printer with Null Connector (figure)	14-7
	Direct Trase to Parallel Printer using Serial/Parallel Converter (figure)	14-8
	Indirect Trase to PC using a Modem Connection	14-8
15.	COMMUNICATIONS: SENDING/RECEIVING DATA	15-1
	Finding Procomm 2.4.3	15-1
	How To Set Up ProComm 2.4.3 on a PC	15-1
	How To Set Up Trase.....	15-1
	How To Exit ProComm	15-2
	How To Set Up Windows Terminal Program On A PC	15-2
	Sending Individual Data	15-3
	Sending Individual Graphs	15-3
	Sending All Graphs In One Storage Area	15-3

	The Three Sending Formats	15-4
	Readings Sent as Printer Format	15-4
	Readings, Printer Formats seen in Excel	15-4
	A Graph Sent in Printer Format	15-5
	Graph, Printer Format as Seen in Excel	15-5
	A Reading Sent in Comma Format	15-6
	Readings, Comma Format, as Seen in Excel	15-6
	A Graph Sent in Comma Format	15-7
	Graph, Comma Formatas seen in Excel	15-7
	Readings Sent in 1-2-3 Format	15-8
	Readings, 1-233 Format, as Seen in Excel	15-8
	A Graph Sent in 1-2-3	15-9
	Graph, 1-2-3 Format, as Seen in Excel	15-9
	WinTrase remote control software for data collection and analysis	15-10
	Data Collection from Trase Systems	15-10
	Display and Analysis of TDR Waveforms using WinTrase	15-10
	Data Collection from Trase	15-10
	Data Collection form Tektronixz Systems	15-11
16.	MULTIPLEXING WITH THE MODEL 6022 MULTIPLEXER	
	CONTROL BOARD AND MULTIPLEXER CARDS	16-1
	Using The Multiplexer Screen	16-3
	Call Up Screen	16-3
	Multiplexer Configuration	16-3
	Making An Individual Moisture Measurement Reading Through the Multiplex System Using The Measure Screen	16-4
	Making An Individual Reading Through The Multiplex System Using the TDR Screen	16-5
	Autologging Through The Multiplex System	16-5
	Selecting Channels To Autolog	16-5
	Setting Up The Autolog Parameters	16-5
17.	MAINTENANCE AND TROUBLESHOOTING	17-1
	Care And Maintenance	17-1
	Trase will Not TurnOn When Pressing On Enter Key	17-1
	Trase Will Not Zero Set	17-1
	Unable to Measure Moisture	17-1
	Time Measurement Failure	16-2
	Initializing The Trase Processor	17-2
	Accessory Items	17-2
	Troubleshooting the Autolog Program with Trap Percentage	17-3
	Enter The Trap Percentage	17-3
	Review Collected Data	17-3
	Manually Determining The Moisture Percentage	17-4
	Downloading The Diagnostic Data to Printer or Computer	17-4

1. YOUR NEW TRASE SYSTEM

The Model 6050X1 Trase System uses Time Domain Reflectometry (TDR) to measure instantaneously the volumetric water content of soils and other moist media. Metal Waveguides for depth measurements ranging from 15 cm to 70 cm are available. They can be used in a portable manner or permanently installed for periodic moisture monitoring in the same location. The volumetric moisture content is displayed, and the graph of the TDR pulse can also be displayed. The moisture reading and the graph of the TDR pulse can be tagged for identification and stored for later analysis. The Trase System can be programmed to autolog moisture readings. Provisions are made for enhancing the amount of memory storage as well as the battery pack capacity. All stored data can be transferred via an RS-232 port to external printers or computers for further processing. The Trase unit is designed for rugged field use and is environmentally sealed to prevent damage to sensitive electronic components.

Unpacking

The Model No. 6050X1 Trase System shipped to you was thoroughly tested before shipment. When packed, it was in perfect order. Unpack with care being sure to remove all packing material. Follow the instructions carefully in order to assure long, trouble-free service.

Cautions and Warnings

Handle all components of the system with care to avoid any damage to delicate electronic components.

Any damage found upon receipt should be reported immediately to the transport carrier for claim. It is important that you save the shipping container and all evidence to support your claim.

Be sure to read all operating instructions thoroughly before operating the unit.

When in use, static discharge to Waveguides or Waveguide Sockets may cause damage to sensitive electronic components.

Operating the system when the "LOW BATTERY" message is showing can result in incorrect readings and can cause loss of stored data.

Not Liable for Improper Use

Trase involves proprietary electronic circuits and hardware. Repair of this precision instrument requires highly specialized equipment. For this reason, we must insist on return for any major repair work. Tampering with the Trase in any unauthorized manner prior to return will void warranty and make the user liable for costs of repair.

Soilmoisture Equipment Corp. is not responsible for any damage actual or inferred for misuse or improper handling of this equipment. Trase is designed to be used solely as directed by a prudent individual under normal conditions in the applications intended for this instrument.

Measuring Range

0-100% volumetric moisture content

Measuring Accuracy

±2% full scale or better with the standard waveguide connector

Operating Temperature

0° to +45°C Do not store below -20°C

-5° to +45°C Autologging without use of Display

Power Supply

2 ea, sealed, gelled electrolyte batteries, supplied. Total capacity: 7 amp hr./ea. Recharge time, 12 hrs.

Quiescent Current 0.02 mA typ., 0.1 mA max.

Auxiliary power input 18-24 volts AC or 18 volts DC, 1.5 amp for battery recharge or independent operation.

External battery input, 12 volts, for independent operation.

Connecting Port

BNC port - For waveguide connection

RS-232 serial port - (DB25), For data transfer

Multiplex port - (DB15), for sequence switch access and for unattended logging of multiple sites using external equipment.

Power Port - 8 pin DIN

Memory

- * Standard 256 Kb memory with storage capacity greater than 180 graphs/5,600 readings.
- * Optional 4-Mb memory board increases storage to greater than 3,900 graphs/122,800 readings.
- * Automatic data tagging of reading time/date/reading number plus user defined label.
- * Autologging capability with reading interval range from one per minute to one per 100 days.

Electronic Particulars

Measuring pulse amplitude 1.6 volt peak, rise-time 125 ps(pico-seconds)

Sampling resolution, 10 ps

Sampling windows, 10, 20, 40 ns

Total Sampling Range 0-320 ns

Sample Points, 2048 measured, 1200 stored

Repetition Rate, 1.5 MHz

Graphic display - 128 x 256 dot supertwist matrix, backlit LCD

Battery charge status indicator lights (3)

Circuit breaker protection

Hardware - 8-slot card cage, 3 system boards, 5 optional slots

Included Items

1 Trase system (6050X1)

1 Waveguide connector (6002F1)

1 Set of 15 cm long waveguides (6008L15)

1 20 cm long buriable waveguide (6005L2)

1 Battery charger (6050V1200-240)

1 Operating instructions (0898-6050X1-1of4)

2. PRINCIPLES AND TECHNIQUES OF OPERATION

Theory

The speed with which an electromagnetic pulse of energy travels down a parallel transmission line depends on the dielectric constant, (K_a), of the material in contact with and surrounding the transmission line. The higher the dielectric constant, the slower the speed.

Soil is composed, in general, of air, mineral and organic particles, and water. The dielectric constants, K , for these materials are:

Air	1
Mineral Particles	2-4
Water	80

Because of the great difference in the dielectric constant of water from the other constituents in the soil, the speed of travel of a microwave pulse of energy in a parallel transmission line buried in the soil is very dependent on the water content of the soil.

When a microwave pulse travels down a transmission line it behaves in many ways like a beam of light. Discontinuities in the transmission line and surrounding material cause some of the microwave energy to be reflected back through the line. When the pulse reaches the end of the transmission line, virtually all the remaining energy in the pulse is reflected back through the line; much the same as a beam of light traveling down a tube and being reflected back by a mirror at the end of the tube.

These characteristics make it possible, with sophisticated electronics, to measure the time required for a microwave pulse to travel down a known length of transmission line, referred to as “Waveguides”, buried in the soil.

The “apparent” dielectric constant, K_a , of the air-soil-water complex can then be determined by the formula:

$$K_a = \left(\frac{t c}{L} \right)^2$$

Where “ L ” is the length of the Waveguides in centimeters, “ t ” is the “Transit Time” in nanoseconds (billionths of a second), and “ c ” is the speed of light in centimeters per nanosecond. The “Transit Time” is defined as the time required for the pulse to travel in one direction from the start of the Waveguide to the end of the Waveguide.

If the soil is completely dry, K_a will be 2 to 4. If 25% of the volume of the soil is water, K_a will be approximately 11-12. For agricultural soils the value of K_a , the “apparent” dielectric constant, depends primarily on the volumetric water content of the soil and is largely independent of the type of soil.

The relationship of the K_a value to the volumetric water percentage has been established by careful measurements of K_a in test cells prepared with accurately known volumes of water in soil. This relationship is then used to automatically convert field measurements of K_a to the volumetric water content of the soil.

The Measurement System

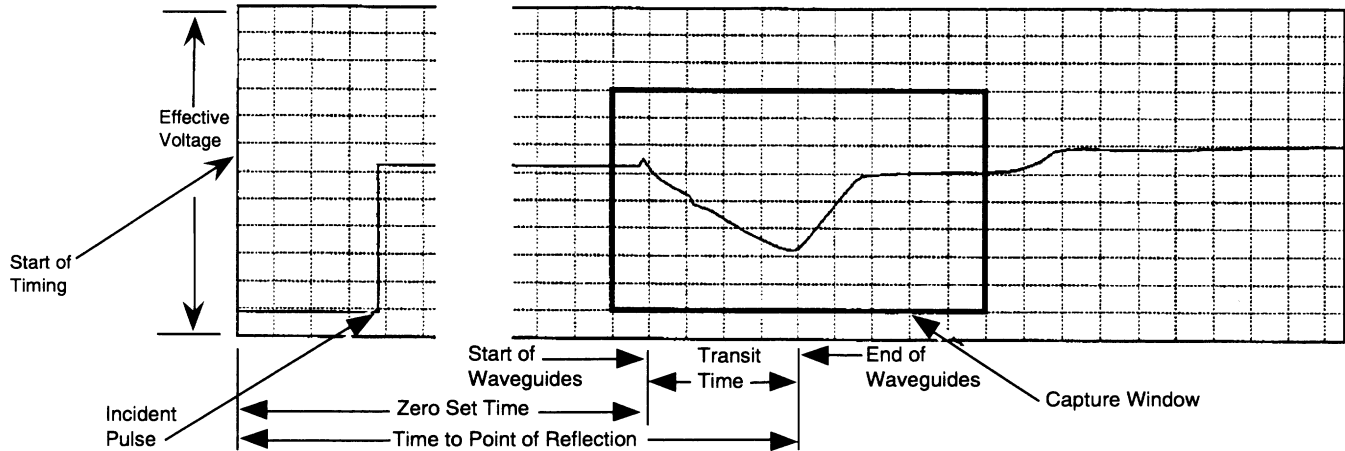

Fig. 2-5

The TDR Processor incorporates a very accurate timing system capable of measuring time in picoseconds (a picosecond is one trillionth of a second). When making a measurement, a long series of timing cycles is initiated. Soon after the start of each timing cycle, a “fast rise time” pulse of electricity, referred to as the Incident Pulse, is generated and sent down the transmission line consisting of the coaxial cable and the waveguides buried in the soil.

After the start of a Timing Cycle, sophisticated electronic components and software measure the “Effective Voltage” of the transmission line at a precise moment. On the first cycle, for example, a measurement would be made 10 picoseconds after the “start of timing”. This value would be stored. On the next cycle, the measurement would be made 20 picoseconds after the “start of timing”. This value would be stored. For each successive cycle a measurement would be made 10 picoseconds later than the previous cycle. Each measurement is stored.

The process is repeated, timing cycle by timing cycle, until the stored values of the “Effective Voltage” cover the complete time range of interest. For example the 10 ns (nanosecond) capture window uses 1200 ea. 10 ps (picosecond) readings, spanning 12 ns. This process is then repeated several times to determine the “average” value for each of the 1200 reading points. Analysis, including tangent fitting is then made on this (1200 point) TDR waveform, to determine start and end reflection. The developed transit times information in turn provides the key in calculating the volumetric moisture content. When these processes have finished, the final 1000 reading points are displayed on Trase as the TDR Graph. However, the full 1200 points are retained in memory if the graph is “saved”.

The sampling time interval may be changed for different applications; the start of the sampling process is determined by the function being performed.

In Fig. 2-1, when you “Zero Set” Trase before making a series of readings, the “Zero Set Time” is being determined as shown above. When you make a reading, the “Time to Point of Reflection” is being determined. The difference between

The Capture Window

these two times is the “Transit Time” which is used to calculate the K_a value, as described above under “Theory”. Trase software then determines from a pre-programmed “look up” table the appropriate volumetric water percentage.

For moisture measuring purposes, it is only that portion of the pulse represented by its Transit Time on the buried Waveguides which is of importance. For the user’s convenience, Trase software has been designed to capture and display in a “Window” only this portion of the complete graph. The “Window” starts before the “Zero Set” time is reached. The “Zero Set” time is the time at which the pulse starts down the Waveguides.

A choice of three window lengths is available, 10, 20, and 40 nanoseconds. The selection is made in the “Setup Screen”. The 10 nanosecond length is set at the factory since this gives the greatest resolution when working with Waveguides of 15 or 30 cm lengths.

When using long Waveguides in very wet soils, the “Transit Time” may exceed the length of the window, as shown. A measurement can only be made if the entire “transit time” lies within the capture window.

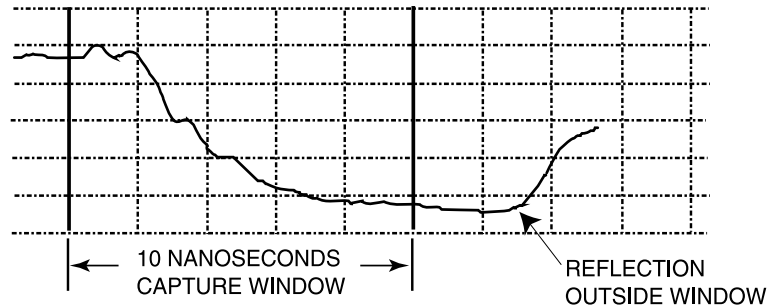

Fig. 2-3

In this case, the transit time cannot be measured and it is necessary to change to a longer time window, as shown.

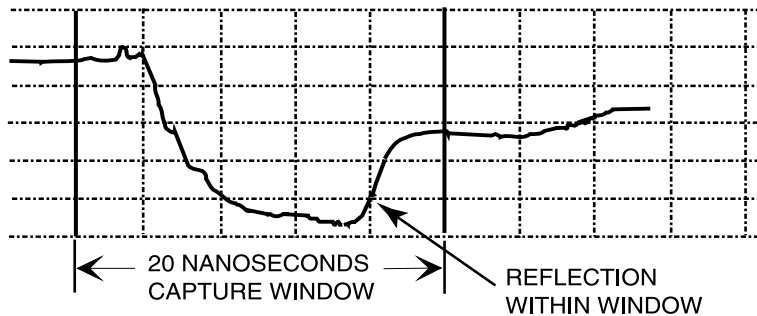

Fig. 2-4

The “Transit Time” while in the Waveguides can now be displayed and measured.

The 40 nanosecond Capture Window provides for greater Waveguide lengths or unusual conditions that may be found in some applications.

The Meaning of Various Graph Features

When the pulse of electricity travels down the Waveguides its speed is influenced substantially by the surrounding soil or other media. The resultant graph of the pulse reveals much about the surrounding soil or media.

Waveguide Connector only, no Waveguides

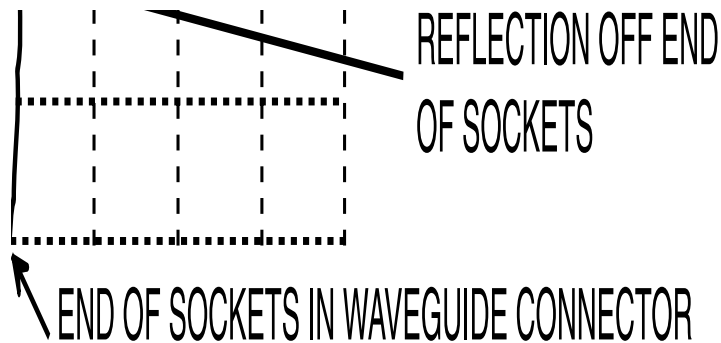

Fig. 2-4

Above is a typical graph of the Waveguide Connector without Waveguides mounted. The bottom of the depression corresponds to the end of the Waveguide sockets in the connector. In this case this is the end of the transmission line and the pulse energy is reflected back through the line at this point.

Waveguides in Dry Soil

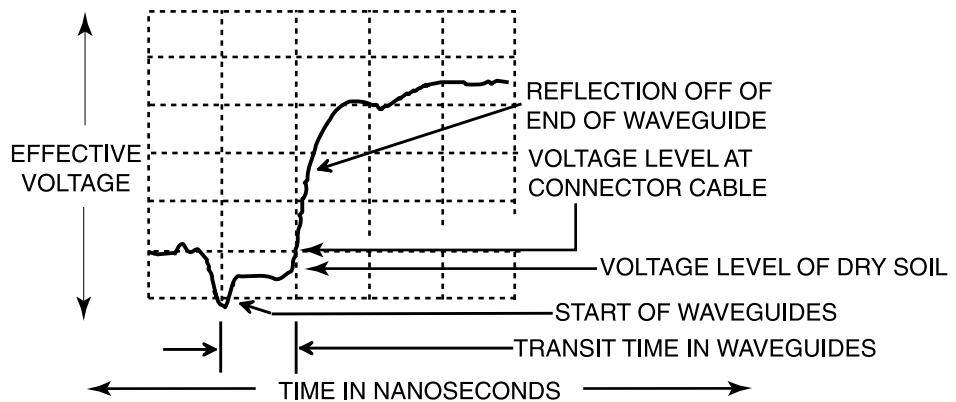

Fig. 2-5

In dry soil there is practically no attenuation (loss) of the pulse energy as it travels along the Waveguides. This is indicated by the small difference in height between the pulse in the connecting cable and the pulse while in the Waveguides (Fig. 2-5).

Waveguides in Moist Soil

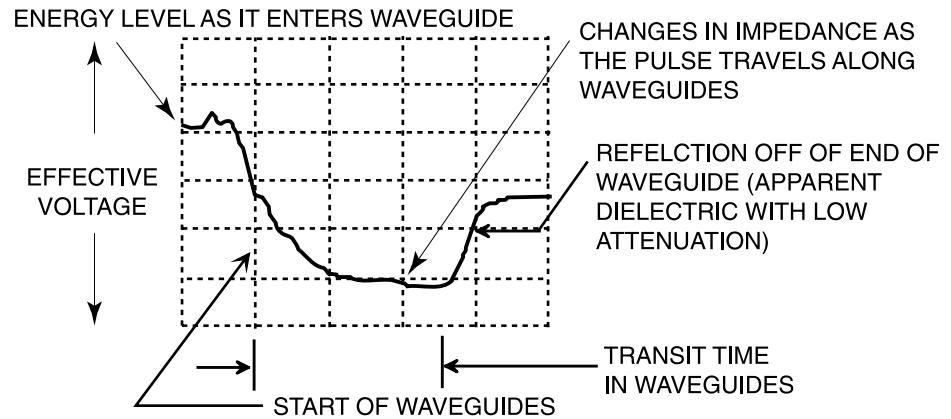

Fig. 2-6

In moist soil there is considerable attenuation (loss) of the pulse energy as it travels along the Waveguides. This is indicated (Fig. 2-6) by the large difference in height between incoming pulse energy as it enters the Waveguides and the energy level at the reflection off of the ends of the Waveguides.

Waveguides in Saline Soil

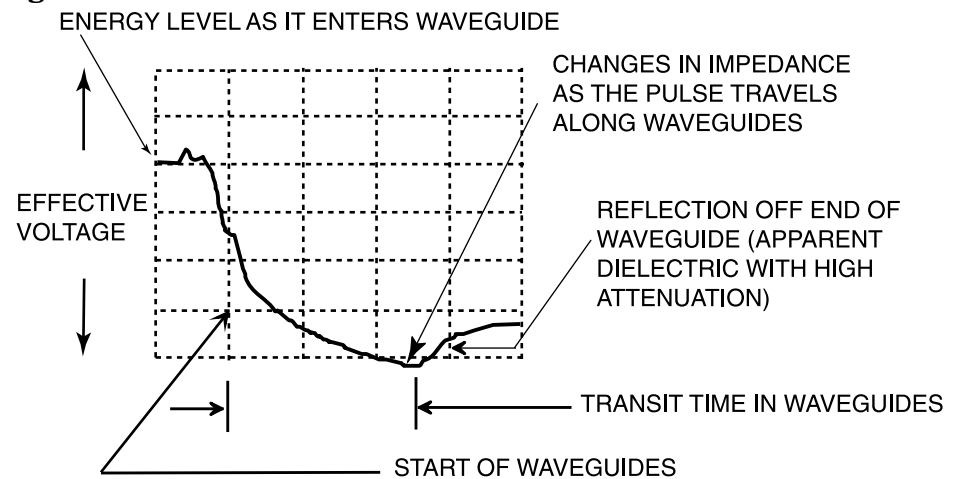

Fig. 2-7

In a saline soil (high bulk electrical conductivity/high attenuation), with the same moisture content as a nonsaline soil, the attenuation (loss) of pulse energy is much greater as it travels along the Waveguides. This is indicated (Fig. 2-7) by a much smaller, and less energetic pulse being reflected off of the ends of the Waveguides. The reflected pulse shows the loss of energy by the smaller height of the reflected pulse.

Note

In highly attenuated environments (high bulk electrical conductivity EC, unusual clays of high water content) TDR waveform analysis may be hindered by the lack of a recognizable end reflection. This frequently can occur in areas where strong fertilizers are applied or where EC values are elevated as a by-product, such as rock salt applications in the winter time. If you have encountered this type of situation or will be monitoring in high EC environments, we suggest the use of our Model 6005CL02 Buriable Waveguide, Coated or our Model 6008 CL series of coated Waveguides in lengths from 15cm-60cm. Both provide reliable end reflections in 50.0 ds EC conditions.

Soil dry at top of Waveguides and moist at bottom of Waveguides

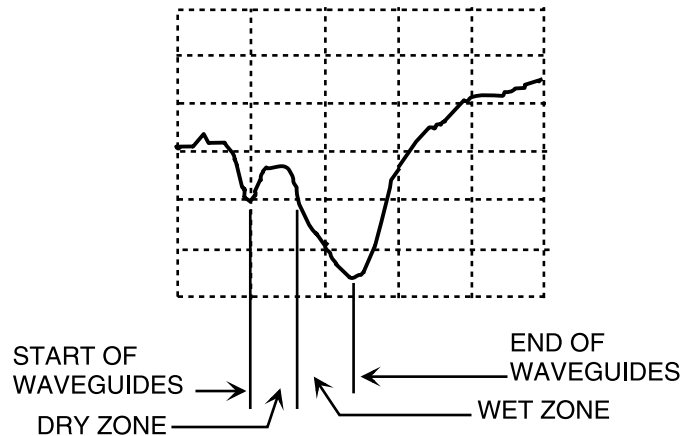

Fig. 2-3

Soil moist at top of Waveguides and dry at bottom of Waveguides.

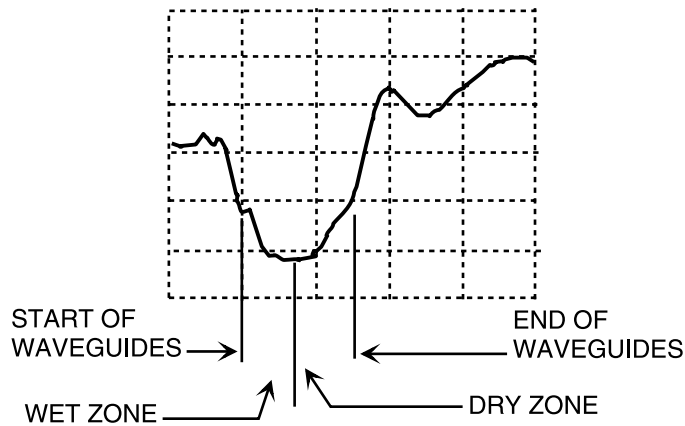

Fig. 2-9

Determine Ka

To determine K_a , the "apparent" dielectric constant of the soil, it is necessary to have an accurate measure of the travel time of the pulse along the Waveguides.

Measuring the Transit Time accurately depends on knowing exactly when the pulse is reflected off of the ends of the Waveguides.

Because of the nature of the pulse of electricity, the point of reflection is not sharp and steps have to be taken to further define this point. The graph below illustrates the manner in which the point of reflection is determined.

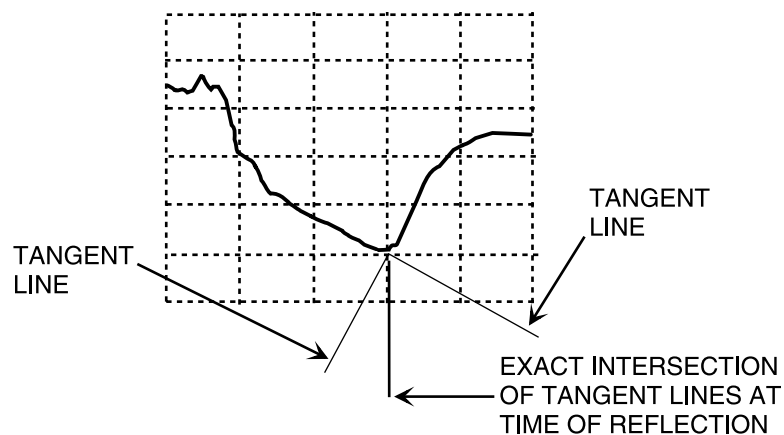

Fig. 2-10

Tangents are constructed to the graph of the incoming pulse and to the graph of the reflected pulse, as shown. The intersection of the two tangent lines is the specific point of reflection.

The Trase software automatically constructs these tangent lines and determines the intersection point in the process of calculating the Transit Time of the pulse in the Waveguides and the subsequent determination of K_a .

The Graph Screen and the associated Time Bars allow you to make independent measurement of the Transit Time in the Waveguides using the “intersecting tangent” method. K_a is then calculated using the formula given under “Theory”. See the section on “Using the Graph Screen” for time measurement details.

The following two pages show the relationship of the K_a value to the volumetric moisture percentage in soil.

The heavy line indicates the moisture percentage displayed by Trase for the corresponding K_a value calculated from the moisture measurement sequence.

These graphs can be used to develop moisture percentages from K_a values determined independently by time measurements made on graphs of the TDR pulse using the Graph Screen.

Relationship of K_a to Moisture Percentage

The graph of the relationship of K_a to volumetric moisture content was developed using test cells carefully prepared to accurately known volumetric moisture contents.

The K_a value for a given volumetric moisture content is not exactly the same for all types of soils. The graphs indicate the differences encountered for 3 types of soils. These differences appear to be due to differences in bonding of water molecules to differing minerals in the soil as well as other physical characteristics that are not fully understood at this time. The differences shown, however, only result in a minor difference in the evaluation of the moisture content.

RELATIONSHIP OF DIELECTRIC CONSTANT, K_a TO VOLUMETRIC WATER CONTENT OF SOILS

— Solid Line Gives K_a /Water Content Relationship Utilized by TRASE
 Dotted Lines Show 2% Limit of Accuracy

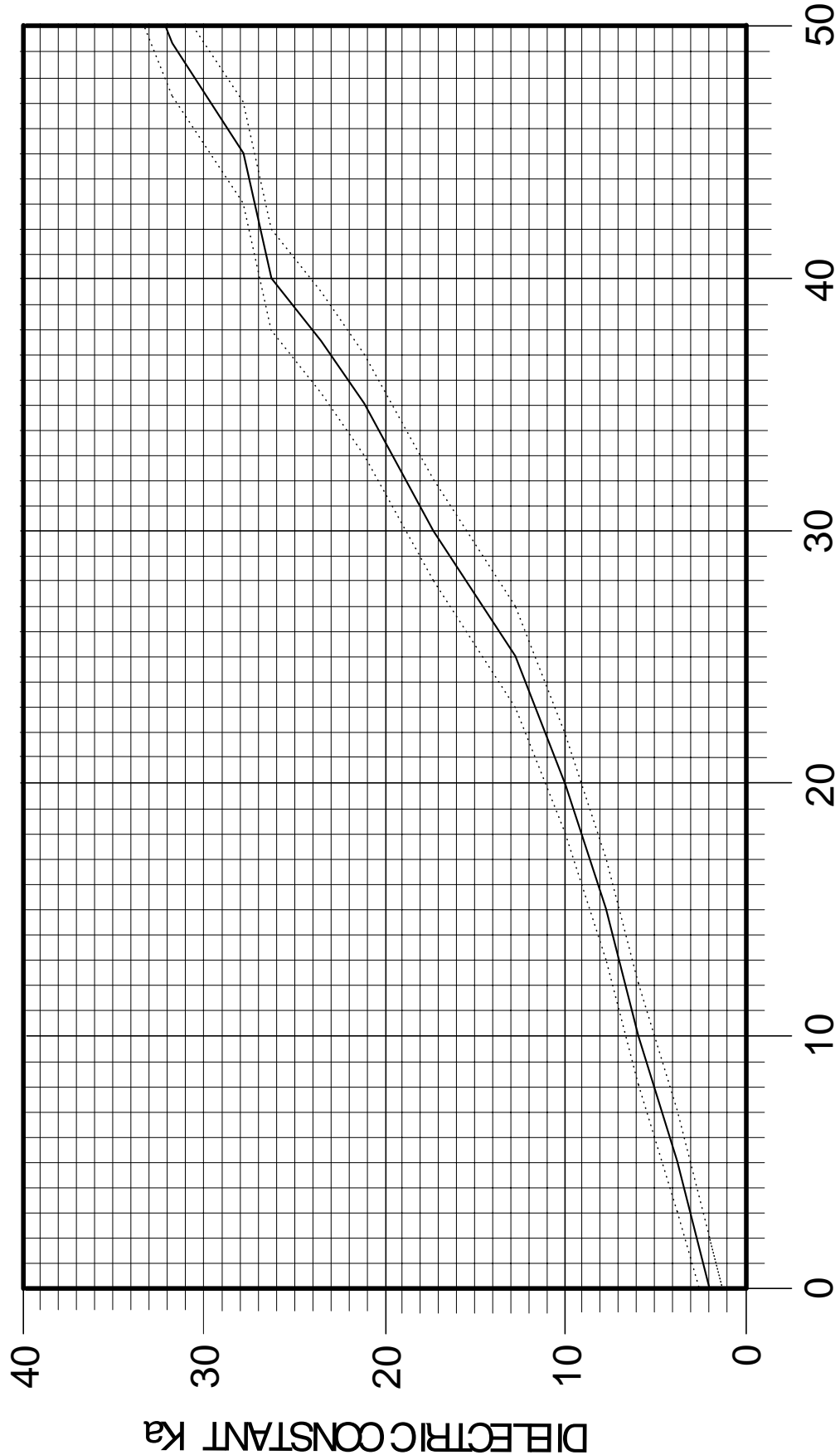

Graph 2-1

RELATIONSHIP OF DIELECTRIC CONSTANT, K_a TO VOLUMETRIC WATER CONTENT OF SOILS

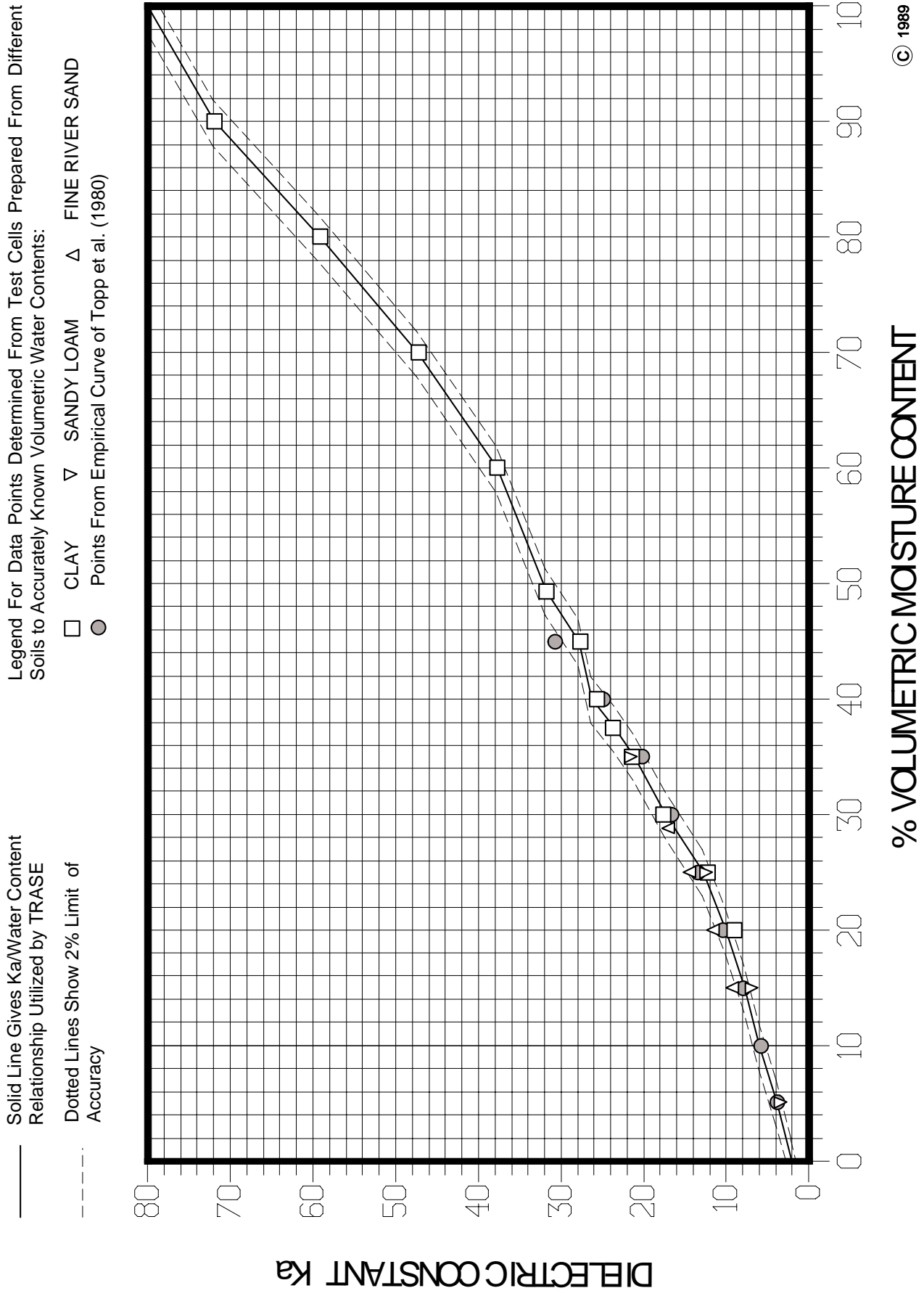

© 1989

Graph 2-2

3. ACQUAINT YOURSELF WITH THE PARTS

Storage Cover and Contents



Fig. 3-1

The Storage Cover provides a convenient place to store the Waveguide Connector, 15 cm long Waveguides, and other miscellaneous small items needed in making field measurements of soil moisture.

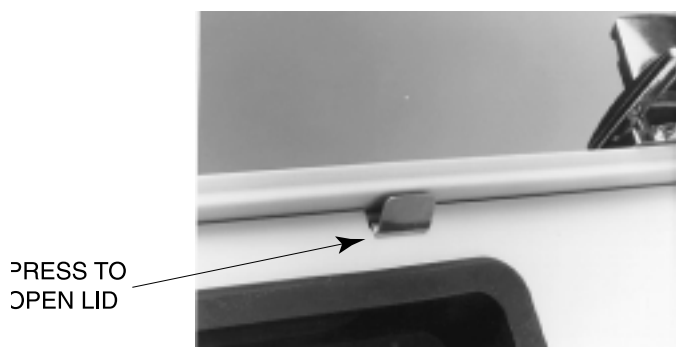

Fig. 3-2

To open the Cover Lid, simply push back on the spring loaded Lid Catch, as shown.

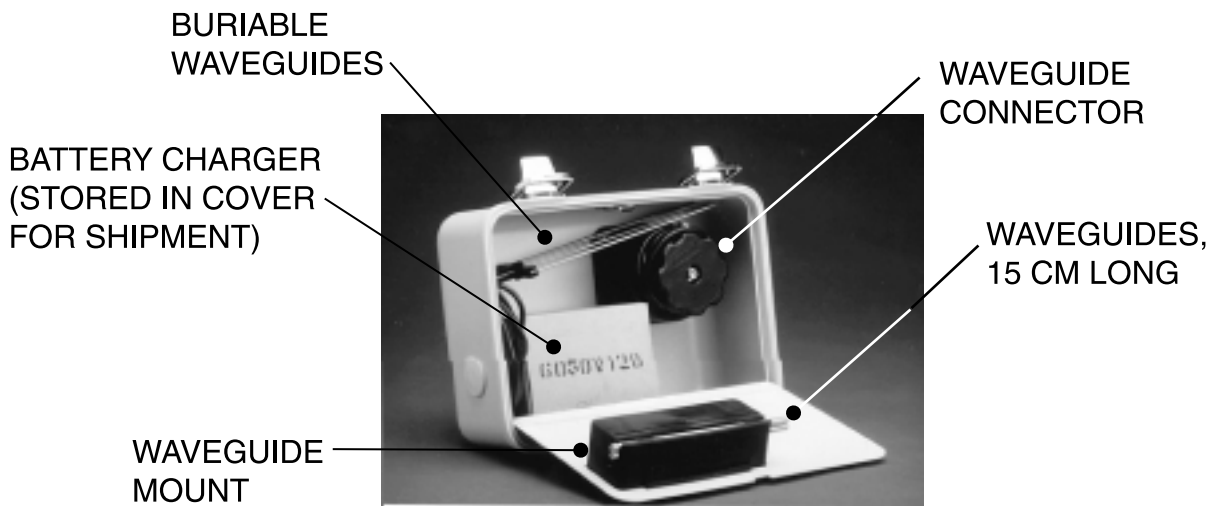

Fig. 3-3

The Waveguide Connector is removed from its mount by grasping the connector and pulling directly out and away from the mount. The 15 cm long Waveguides can simply be lifted out of the slot in the flexible Waveguide Mount. The spring force provided by the mount keeps the Waveguides snugly in place during storage.

The Battery Charger is packed in the Storage Cover for shipping purposes, but is not usually stored there during use of the equipment.

The Waveguide Mount is normally left in place in the Cover Lid. However, when external accessory equipment requires direct cable connection to the TDR Processor under environmentally sealed field conditions, it is necessary to remove the Waveguide Mount to provide a pathway for the connecting cables.



Fig. 3-4

To remove the Waveguide Mount, squeeze the flexible sides together until the locking rib on the mount clears the edge of the hole in the Cover Lid.

The mount can then be pushed through the rectangular hole in the Cover Lid, as shown. The Cable Grommet is removed, when needed, by pushing on the center of the grommet from the inside, as shown.



Fig. 3-5

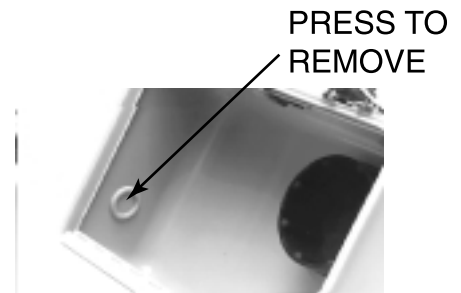

Fig. 3-6

Waveguide Connector and Waveguides

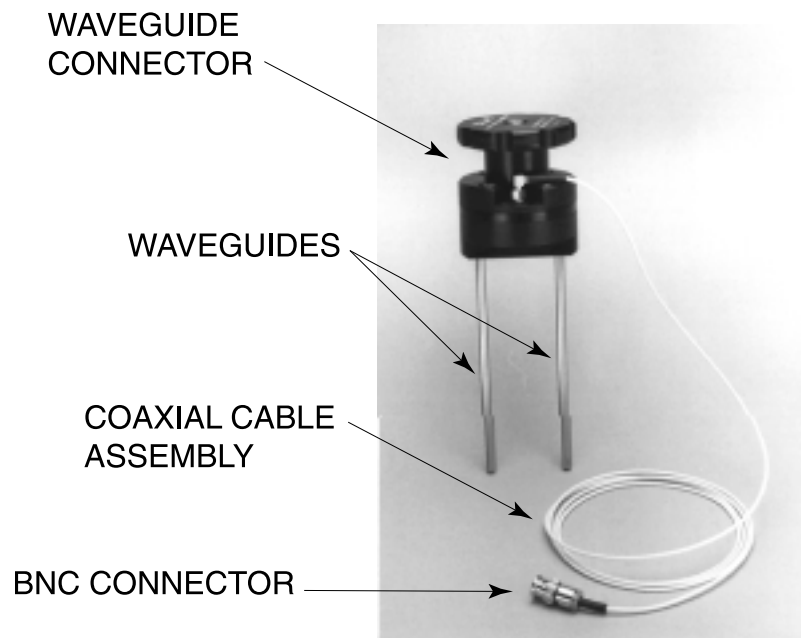

Fig. 3-7

The Trase Waveguide Connector is specifically engineered to minimize soil disturbance and simplify the procedure for making numerous and repeated measurements. The entire rugged, polycarbonate housing is hermetically sealed to prevent moisture damage to internal electronic components as well as providing protection for the circuitry during field use. A convenient electrical fitting allows for easy replacement of the Coaxial Cable Assembly when necessary.

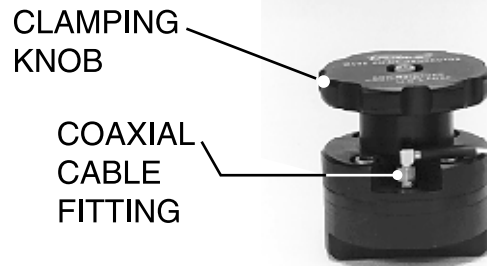

Fig. 3-8

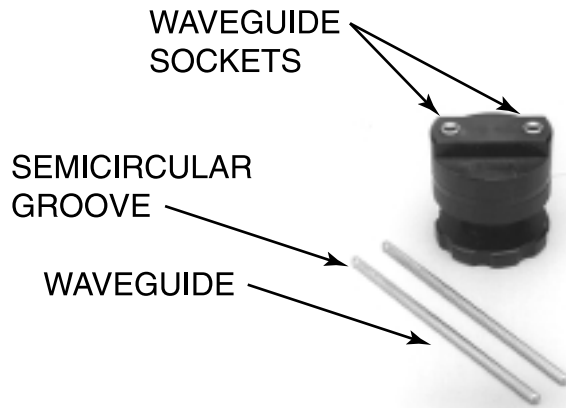

Fig. 3-9

To insert the Waveguides, turn the Clamping Knob counterclockwise until it stops. The end of the Waveguide that has the groove is then inserted into the Waveguide Sockets. You must always insert both Waveguides into the Connector for proper clamping operation. When the Clamping Knob is turned clockwise, an internal mechanism forces two stainless steel balls into the grooves in the Waveguides to lock them securely in place and to make excellent electrical connection.

Note

To prevent measurement errors, insure that the Waveguides are fully inserted into the sockets before tightening the Clamping Knob.

After the Waveguides are inserted, turn the Clamping Knob clockwise to tighten the Waveguides in the Waveguide Sockets. **Hand tightening is sufficient. Do not overtighten.**

The Waveguides supplied with the unit are 15 cm long. Accessory Waveguide sets are available in 30 cm, 45 cm, 60 cm, and 70 cm lengths. Waveguides are all made from stainless steel.

Coaxial Cable Assembly

The Coaxial Cable Assembly is a part of the Waveguide Connector. It can readily be replaced with a new cable when required.



Fig. 3-10



Fig. 3-11

If it becomes necessary to replace the Coaxial Cable Assembly, use a 5/16 inch open end wrench to loosen the hex nut on the coaxial fitting. The hex nut can then be unscrewed.

For proper compatibility with Trase software, it is necessary to use Waveguide Connector Cable, Part No. 6003L78, as a replacement. The replacement can be installed by reversing the procedure. Tighten down the hex nut completely with the cable protruding out of the fitting to the side, as shown, to prevent accidental damage to the cable.

Note: It is only necessary to tighten the hex nut 1/4 turn past “finger tight”. Use a wire tie to secure the cable with one loop around the clamping knob to provide strain relief at the coaxial fixture.



Fig. 3-12

Buriable Waveguide



Fig. 3-13

The Buriable Waveguide provides additional flexibility in making moisture measurements. It is designed to be completely buried in the soil for evaluating moisture at specific depths and can be left in the soil indefinitely.

The Buriable Waveguide can also be grasped by the end housing and inserted vertically in the soil or other media.

A BNC Male Coaxial Fitting is used to connect with the TDR Processor directly or through optional extension cables. Select **[buriable]** for the waveguide.

Battery Charger

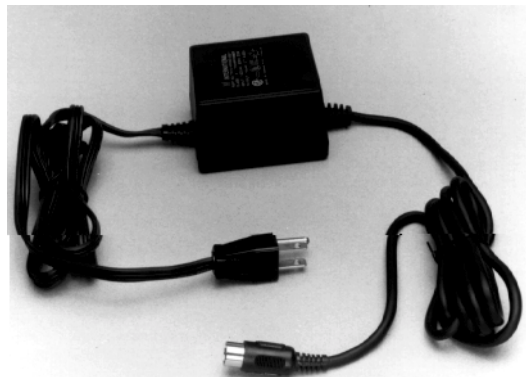

Fig. 3-15

Two types of Battery Chargers are supplied. One is for operation from a source voltage of 110 V, 60 Hz. and the other for operation on 220V, 50 Hz. You will have been supplied the one appropriate for the voltage in your location.

The Charger is plugged into a wall outlet and the Charger Cable is plugged into the Power Port on the control panel of the TDR Processor.

TDR Processor

Housing

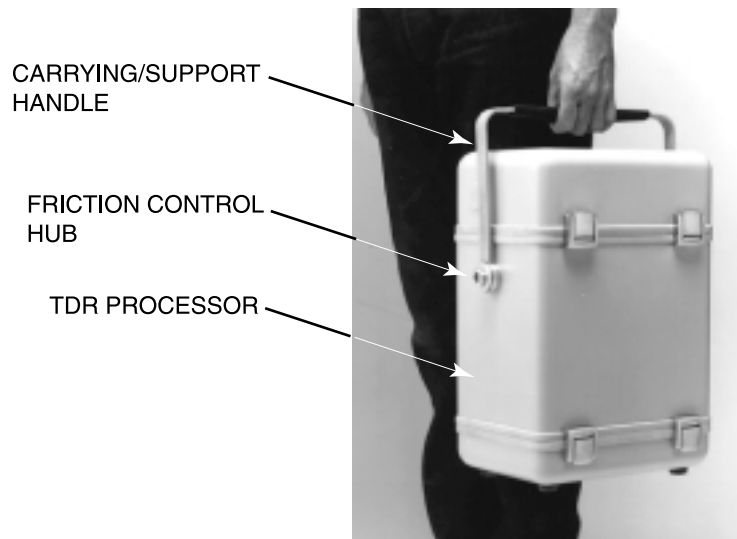

Fig. 3-16

The Carrying/Support Handle, which is a part of the TDR Processor, is friction controlled and serves a number of functions.

The soft molded handle grip makes it comfortable to carry the complete unit into the field.

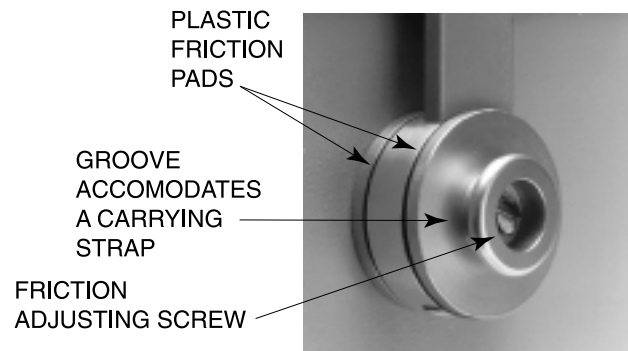

Fig. 3-17

The handle has been adjusted to provide considerable friction. It is desirable to maintain this adjustment to serve the support function that the handle can provide. Friction is increased by turning the Friction Adjusting Screw clockwise and reduced by turning it counterclockwise. A screwdriver is required to make the adjustment.

The groove in the Friction Control Hub will accommodate an “around the neck” carrying strap for field use of the equipment when desirable.



Fig. 3-18

The Carrying/Support Handle is moved to the back of the TDR Processor, as shown, to make a support for the Storage Cover when it is opened.



Fig. 3-19

The Carrying/Support Handle is moved to the front of the TDR Processor, as shown, to support the processor for bench top use. For this type of application the Storage Cover is completely removed from the TDR Processor.

Control Panel

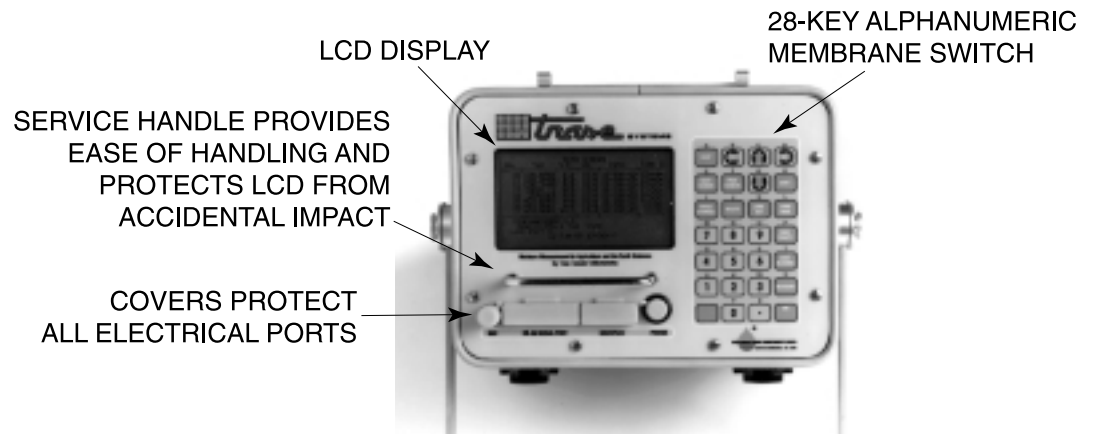

Fig. 3-120

The TDR Processor Control Panel has a hard surface, transparent plastic membrane cover film that seals the faceplate against moisture, dirt, and other contaminants. Avoid contacting this surface with hard, sharp objects and clean only with a moist, soft, clean cloth.

The alphanumeric keypad is designed for fingertip actuation. A slight “click” is felt when the individual key is actuated.

All of the electrical ports are supplied with dust covers to seal them against moisture and dirt during field use of the instrument.

BNC Port



Fig. 3-21

The round, soft rubber cover for the BNC Port is removed by grasping with the thumb and forefinger and lifting up. A flexible tether connected to the RS-232 Serial Port cover assembly keeps the cover safe from loss when the port is in use. To replace the cover, center on fitting, and press firmly down.

The BNC port accepts the standard BNC connector on the coaxial cable of the Waveguide Connector, the Buriable Waveguide, or extension cable when making moisture readings.

RS-232 Serial Port

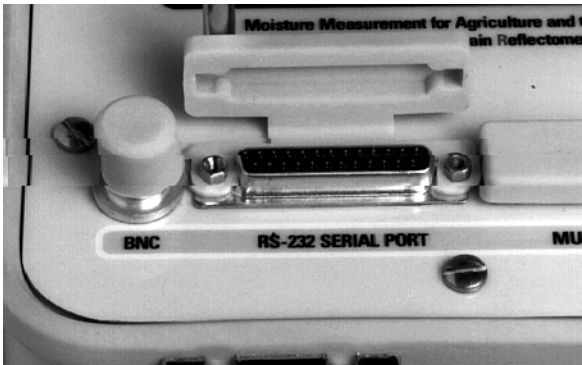

Fig. 3-22

The soft plastic cover on the RS-232 Serial Port is removed by lifting up on the front edge of the cover. A flexible membrane serves as a hinge for the cover and keeps the cover safe from loss when the port is in use. To replace the cover, simply align the recess in the cover with the metal frame on the port and push fully down.

The RS-232 Serial Port allows transfer of stored data to a computer terminal or printer. (See RS-232 Serial Port operating instructions Chapter 13 page 2)

Multiplex Port

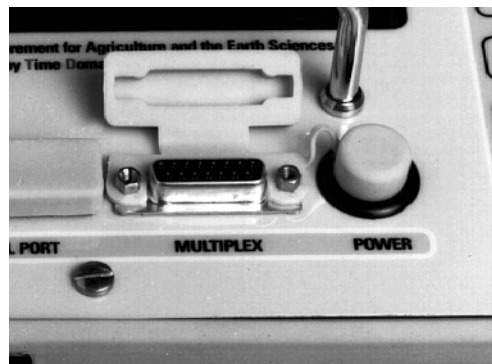

Fig. 3-23

The soft plastic cover on the Multiplex Port is the same design as the cover on the RS-232 Serial Port and is handled in the same way. This cover assembly also has a tether to the Power Port cover.

The Multiplex Port provides for optional connection to external multiplexing instrumentation. (See Multiplexer operating instruction Chapter 13 page 2)

Power Port



Fig. 3-24

The round, soft rubber cover for the Power Port is removed by grasping with the thumb and forefinger and lifting up. A flexible tether connected to the Multiplex Port cover assembly keeps the cover safe from loss when the port is in use. To replace the cover, insert the tubular portion of the cover into the annular groove in the Power Port, and press firmly down.

The Power Port allows battery charging and accepts the plug on the Battery Charger supplied with the instrument. The port also allows use of auxiliary power from a wide range of power inputs. (See Chapter 13 page 1)

Base Panel

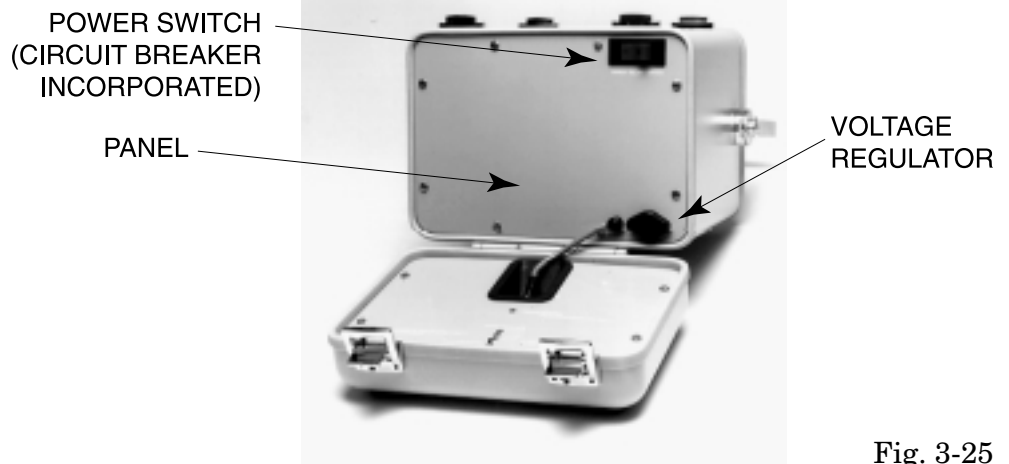

Fig. 3-25

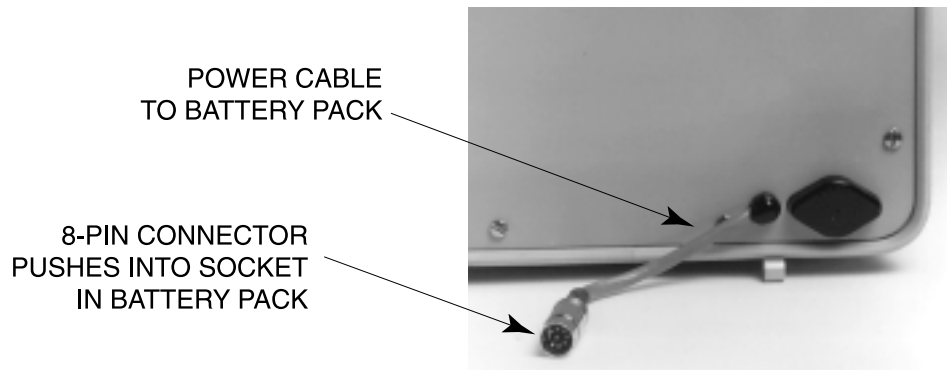

Fig. 3-26

The Base Panel is accessed by unlatching the Battery Pack. The TDR Processor can then be tipped over on its back, as shown. When desired, the Battery Pack can be completely removed from the TDR Processor by disconnecting the Power Cable to the Battery Pack, and releasing the hinge on the side opposite the latches.

The Power Switch is in the “OFF” position during shipment and must be toggled to the “ON” position to operate the TDR Processor. This is a “rocker” type switch. Simply press on the projecting end to actuate. The ‘I’ position is the in use “on” position. The ‘O’ position is the “off” position.

Note: The power switch is also a circuit breaker designed to “trip” protecting internal electronic circuits. If the circuit breaker repeatedly “trips”, contact your nearest Trase dealer.

Battery Pack



Fig. 3-27

The Battery Pack is accessed by unlatching the two lower latches and tipping the TDR Processor on its back, as shown. When required, the Battery Pack can be completely removed from the TDR Processor by disconnecting the Power Cable and pulling out the DIN connector and then unlatching the hinge.

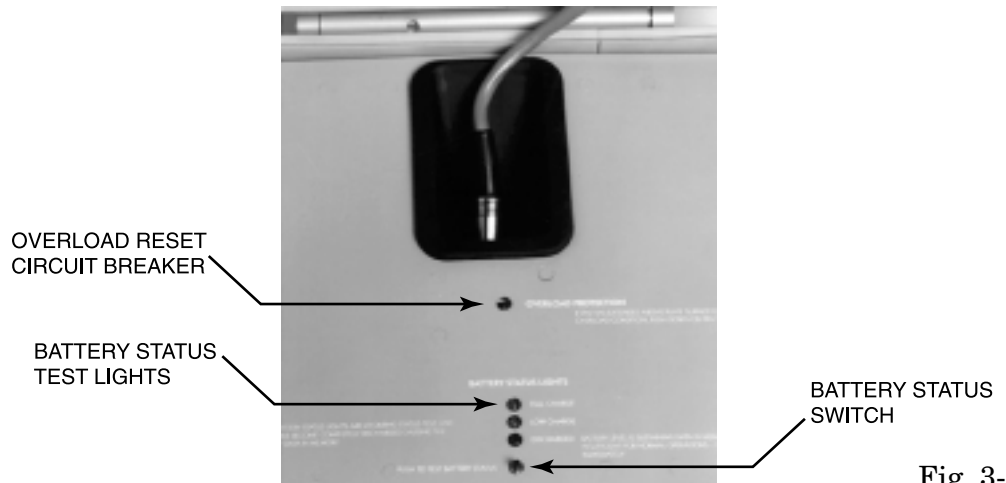

Fig. 3-28

The standard Battery Pack contains two rechargeable batteries for reliable, long-term portable power. The panel on the Battery Pack contains the Overload Reset Circuit Breaker and the Battery Status Test Lights.

If the batteries are subject to an overload, the overload protection circuit breaker is activated and a pin in the center of the breaker pops up above the panel. To reset the breaker simply push down on the pin until it locks flush with the panel. Push the “On/Enter” button to start Trase up again.

Three lights are provided to indicate battery status. To check the status, press down on the Battery Status Switch. A green light indicates full charge, a yellow light indicates the normal operation range, a red light indicates a low or discharged condition.

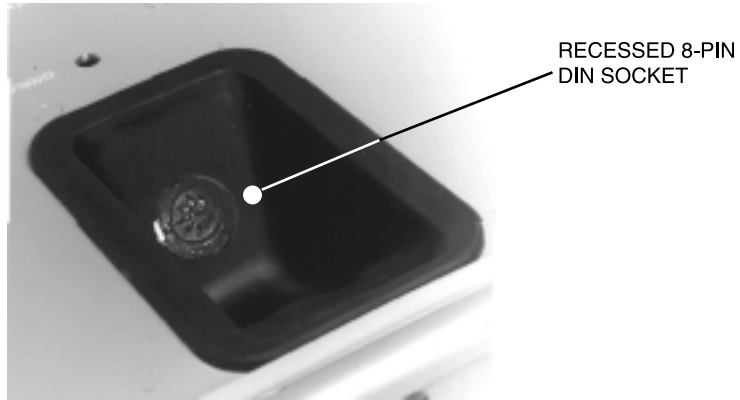

Fig. 3-29

Normally the Battery Pack is left attached to the TDR Processor and charging is accomplished by connecting the Battery Charger to the Power Port on the control panel of the TDR Processor. However, if accessory Battery Packs are used, one Battery Pack can be charged while another Battery Pack is in use on the TDR Processor. Under these conditions, the Battery Charger can be plugged directly into the recessed DIN socket in the Battery Pack.

4. REQUIREMENTS PRIOR TO USE

Check Battery Charge/ Charge Batteries



After unpacking your Trase, the first step in putting it into operation is to check the battery charge status.

Unlatch the two lower latches and tip the TDR Processor on its back, as shown.

The charge on the batteries can now be checked by pushing down on the Battery Status Switch. The battery charge status lights above the Battery Status Switch should light “green” or “yellow”. If the “red” (discharged) light shows, reposition the TDR Processor and close the latches. Connect the Battery Charger to your power source and plug the 8 pin DIN connector on the battery charger into the Power Port on the Control Panel, as shown.

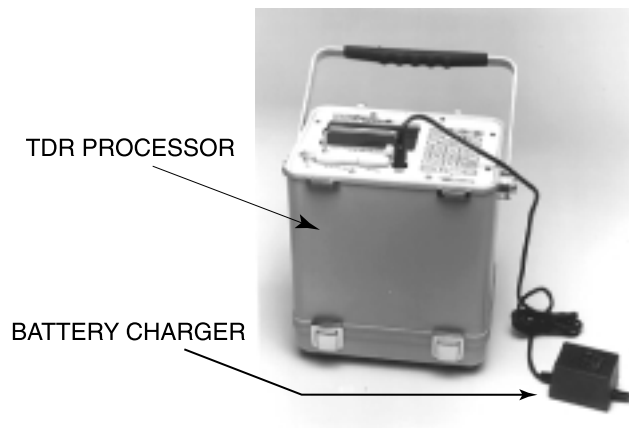

It requires approximately 12 hours to recharge a fully discharged battery.

Turn On Power Switch

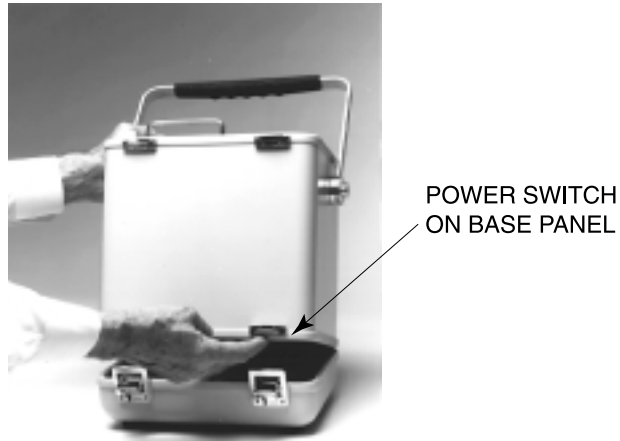

When batteries are fully charged the Power Switch is turned on. To do so, release the latches on the Battery Pack and tip the TDR Processor back sufficiently to access and actuate the switch, as shown.

The TDR Processor can now be operated.

The Power Switch is now left on at all times, including during future battery charging cycles.

Note

Trase can be operated from the Battery Charger alone as soon as it is connected. Trase can be operated during the battery charging process. For full flexibility, it is recommended that initially the batteries be fully charged prior to extensive use.

5. ACQUAINT YOURSELF WITH THE OPERATION OF THE CONTROL PANEL

Activate The TDR Processor



To activate the TDR Processor press the “On/Enter” key, as shown. The Measure Screen will appear. This screen is used when making a moisture measurement.

To conserve battery power, the TDR Processor will remain active for a limited period of time. As received, the TDR Processor will automatically shut off 120 seconds after the last key is pressed.

To reactivate the TDR Processor after it has shut off, simply press the “On/Enter” key. You will return to the last active screen when the unit shut down.

The shut off time period of 120 seconds was selected and set at the factory. There are 4 auto shutoff time periods available, namely 20 sec., 60 sec., 120 sec., or 240 sec., that can be selected. The shortest shutoff time period compatible with the type of work being done is desirable for conservation of battery power. Section 6, “Using the Setup Screen”, covers how to change the auto shutoff time.

Review The Operational Screens

There are a total of 6 operational screens used in the operation of the Trase System, and 1 additional screen if your unit is equipped with multiplexing capability.

Three screens are available in what is defined as the “normal” mode and the remaining screens are available in what is defined as the “shift” mode.

Screens Available In The "Normal" Mode

```

SETUP SCREEN
Copyright 1988-95 SEC      6058C6-2000A
Length units: millimeters <->
Cable loss: 0.0 db/100 ft
Moisture table: CUN <-> Label: Con Unco
Date: (dd-MMM-yy)
Time: (hh:mm:ss)
Capture Window: 10 nS <->
Storage: 1 <-> Label:
Baud Rate: 9600 <->
Stop bits: 1 <-> Modem: None <->
Parity: none <->
Flow control: xon/xoff <->
               commas <->
               240 secs <->
16-JAN-95 0:52:53
    
```

MEASURE SCREEN (FIRST)

No.	Tag	%M	Ch	G	Date	WG	mm
Zero	Error	Ka	Tab	P	Time	Type	
1		0.0	0	0	1-JAN-95	450.0	
13.6		1.0	STD	10	0:01:22	CON	
2		0.0	0	0	1-JAN-95	450.0	
13.6		1.3	STD	10	0:01:50	CON	
3		21.3	0	0	1-JAN-95	450.0	
13.6		10.7	STD	10	2:19:25	CON	
4		21.4	0	0	1-JAN-95	450.0	
13.6		10.8	STD	10	2:49:05	CON	
Storage: 1		<->					
Search: No.		<->					
Look for: 0				16-JAN-95 1:08:31			

DATA SCREEN (SECOND)

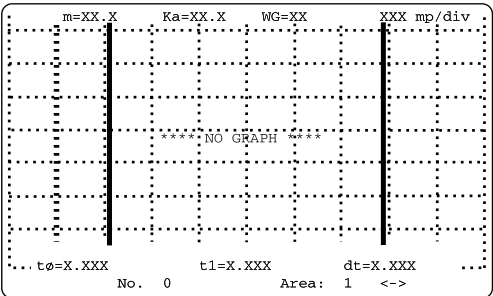

GRAPH SCREEN (THIRD)

When you activate the TDR Processor by pressing the “On/Enter” key, the unit is in the normal mode. In this mode the three screens available to you are: 1) the Measure Screen, used when making a measurement; 2) the Data Screen which displays stored data; and 3) the Graph Screen which displays the stored graph of the TDR pulse and allows you to make time measurements on the graphs.

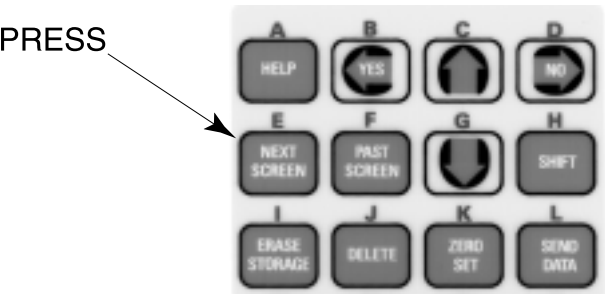

To change from the screen being displayed to the next screen, press the “Next Screen” key, as shown. Repeated pressing of the “Next Screen” key cycles you through the three screens. Continued pressing repeats the cycle.

PRESS

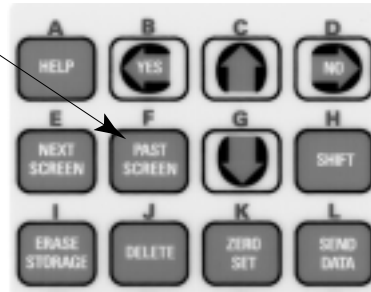

To go back to the screen just previously displayed, press the “Past Screen” key, as shown. Repeated pressing of the “Past Screen” key cycles you through these three screens in the reverse order.

Screens Available In The "Shift" Mode

The screens available to you in the “shift” mode are: 1) the Autolog Screen, used to set time and frequency parameters when autologging data; 2) the TDR Screen, whose function is similar to a cable tester; 3) the Multiplexer Screen, if your unit is equipped with multiplexing capability; and 4) the Setup Screen, used to set the internal clock for time and date, shut down time, units of measure, and data transfer parameters.

```
AUTOLOG SCREEN

Starting date:      (dd-MMM-yy)
Starting time:     (hh:mm:ss)
Cycle interval:    (hh:mm)
Number of cycles:  0      Trap: 0.0%
Save: Readings <->
Sequence switch:  No <-> Time: 1.0 secs
Readings will begin on XX-XXX-XXX XX:XX:XX
An autolog cycle will occur every

NOTE: before autolog begins you must:
+ Set the zero.   + Select the storage.
+ Set WG length. + Check date & time.
                23-JAN-95 21:51:01
```

1) Autolog Screen

```
--TDR SCREEN--

MUX channel: 0      MUX not connected
Start time: XX      nSec
Range time: 10      nSec <->

After setting Start time and range
press MEASURE to digitize. To see
graph go to Graph screen and select
Reading 0. To save graph go to Measure
screen, tag as desired and press
SAVE GRAPH

                23-JAN-95 21:54:51
```

2) TDR Screen

```
--MULTIPLEXER SCREEN--

Starting channel: 0
Ending channel: 0

Multiplexer configuration:
Number of boards= 0
Number of channels= 0

Press MEASURE to scan through all the
channels as an installation check.

                14-JAN-95 10:40:25
```

3) Multiplexer Screen

```
SETUP SCREEN

Copyright 1988-95 SEC      6058C6-2000
Length units: millimeters <->
Cable loss: 0.0 dB/100 ft
Moisture table: CUN <-> Label: Con Unco
Date:      (dd-MMM-yy)
Time:      (hh:mm:ss)

Capture Window: 10 nS <->
Storage: 1 <-> Label:
Baud Rate: 9600 <->
Stop bits: 1 <-> Modem: None <->
Parity: none <->
Flow control: xon/xoff <->
commas <->
240 secs <->

                16-JAN-95 0:52:53
```

4) Setup Screen

To access these screens, first go to the Measure Screen. When the Measure Screen is displayed, press the “Shift” key and then press “Next Screen” key, as shown. When the “Shift” key is pressed the word SHIFT will appear in the lower left corner of the screen.

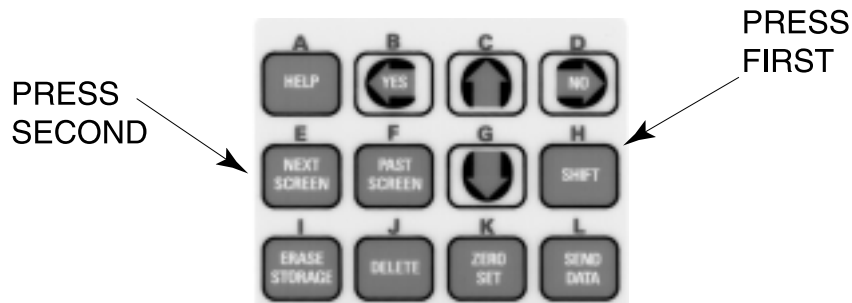

To access the next screen, press “Shift” key again and then press the “Next Screen” key.

These screens can also be accessed in reverse order by pressing the “Shift” key and then the “Past Screen” key.

To get out of the “shift” mode and back to the “normal” mode press either the “Next Screen” key or the “Past Screen” key.

Review Help Screens

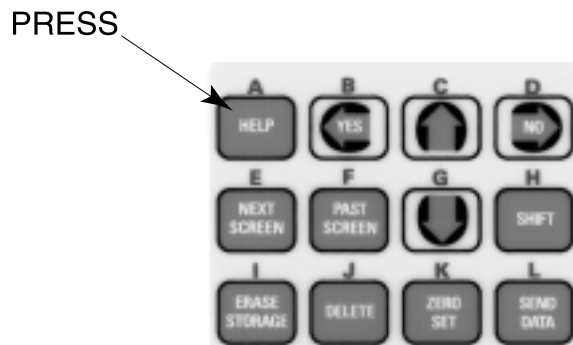

There are “Help Screens” giving a brief list of information for each “Entry field” or “Selection field” that you will be using. Pressing the “Help” key, as shown, will display the information corresponding to the field where the “Cursor” is located. Operation of the cursor is explained below.

In addition, there is also a “Help Menu” available from any of the Help Screens by pressing the “On/Enter” key. The menu contains a list of the various functions you will be performing and an associated key number. Pressing the key corresponding to the particular function you are interested in displays brief operating instructions for that function. Pressing the “Help” key returns you to the “Help Menu”.

Pressing the “Help” key again will return you to the operational screen.

Operate The Cursor

```

SETUP SCREEN
Copyright 1988-95 SEC          6058C6-2000A
Length units: millimeters <->
Cable loss: 0.0 db/100 ft
Moisture table: CUN <-> Label: Con Unco
Date: (dd-MMM-yy)
Time: (hh:mm:ss)
Capture Window: 10 nS <->
Storage: 1 <-> Label:
Baud Rate: 9600 <->
Stop bits: 1 <-> Modem: None <->
Parity: none <->
Flow control: xon/xoff <->
               commas <->
               240 secs <->
16-JAN-95 0:52:53
  
```

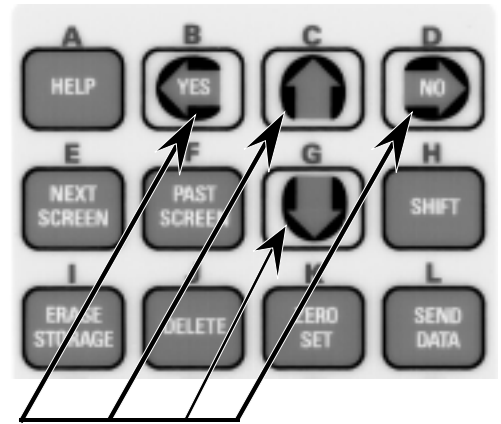

The cursor is displayed as a small black pulsating square in each of the operational screens. It is actuated by the four arrows on the keypad, as shown. Pressing the “up arrow” or “down arrow” key moves the cursor through the various fields in which you have a selection or an entry requirement, usually in an up or down direction. Pressing the “left arrow” or “right arrow” key scrolls between functions or values within a field.

The cursor operation is covered in greater detail in conjunction with the detailed use of each of the various operational screens.

The Time Bars

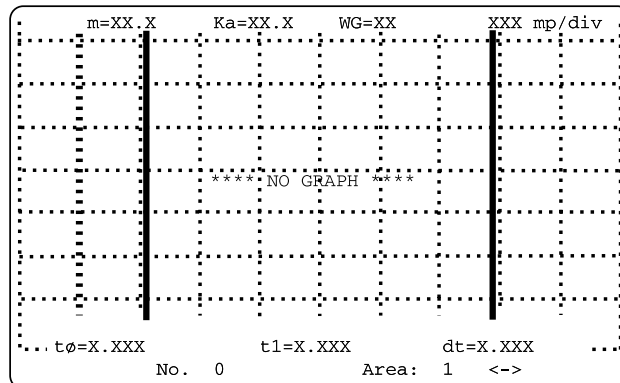

When working with the Graph Screen the “left arrow” and “right arrow” keys are used to move the two vertical Time Bars. When used for this purpose, holding down continually on the arrow key causes the time bar to move at maximum rate. This feature minimizes the time required to position the Time Bars in the desired location.

Detailed operation of the time bars is covered in Section 9, “Using the Graph Screen”.

Enter Numerals

When making an entry in any of the operational screens, the cursor is first positioned in the “field” where the entry is to be made.

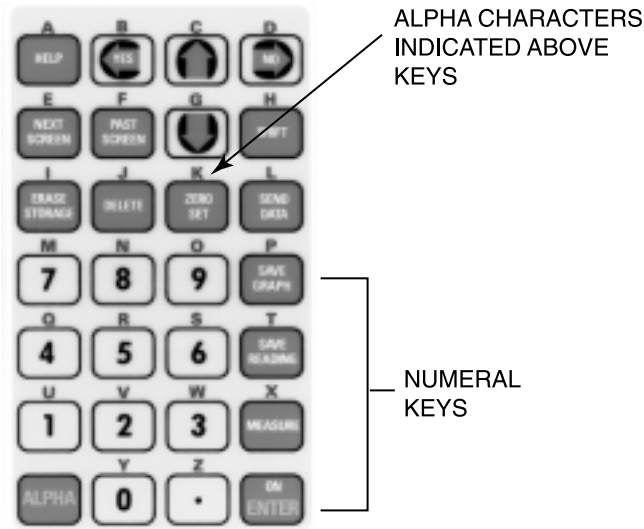

To enter a numeral, press the key corresponding to the numeral desired. Keys are available for numerals 0 through 9 as well as a decimal point.

The numeral entered will be displayed and the cursor will move to the adjacent position to accept the next entry.

Enter Alpha Characters

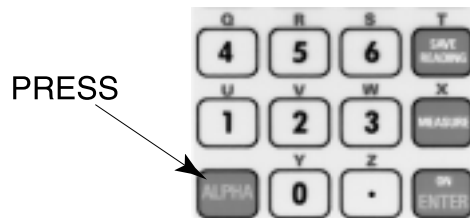

To enter alpha characters first press the “Alpha” key. When this is done the code word ALPHA will appear in the lower left-hand corner of the screen. When the alpha code is displayed on the screen, the entire keypad is dedicated to the alpha characters except the “On/Enter” key and the “Alpha” key. The alpha character for each key is printed above each key. Press the key corresponding to the alpha character desired. Keys are available for alphas A through Z.

The alpha entered will be displayed and the cursor will move to the next adjacent position to accept the next entry.

When entry of alpha characters is complete the “Alpha” key is pressed again to return the keypad to normal operation.

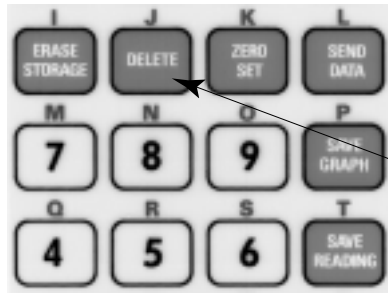

PRESS

If an error is made during entry of numerals press the “Delete” key to remove the entire entry. If an error is made when entering alpha characters it is necessary to press the “Delete” key twice to delete the entry.

When all numerals and alphas needed have been keyed into the “field” where entry is being made, press the “On/Enter” key to complete the entry process.

The Entry operation is covered in greater detail in conjunction with the detailed use of each of the various operation screens.

Zero Set Key



PRESS

When making a moisture measurement using the standard Waveguide Connector, pressing the “Zero Set” key establishes the zero time reference for subsequent moisture measurements. This key is active when the Measure Screen is displayed.

Measure Key



PRESS

Pressing the “Measure” key initiates the moisture measuring cycle which takes several seconds to complete.

The resultant moisture percentage is displayed on the Measure Screen. Readings can be tagged for identification and for storage area, if desired. This key is active when the Measure Screen is displayed.

Storing a Reading or Graph Keys

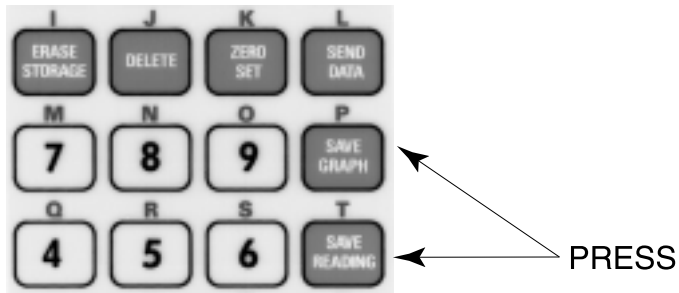

When storing a moisture reading, the “Save Reading” key is pressed. When storing both the reading and its detailed graph of the TDR Pulse, the “Save Graph” key is pressed. These keys are active when the Measure Screen is displayed.

Erasing Stored Data Key

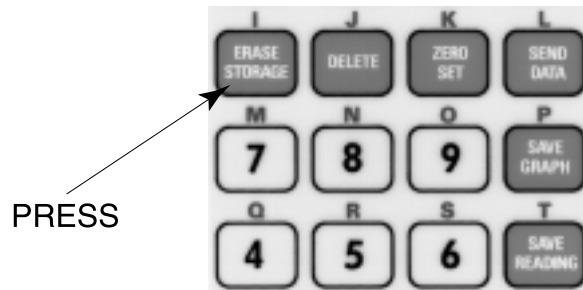

The “Erase Storage” key is used to erase stored data from each of the numbered storage sections. Erasing storage is a two step process for safety reasons. It is used in conjunction with the “Yes” and “No” keys and the Data Screen.

Sending Data Key

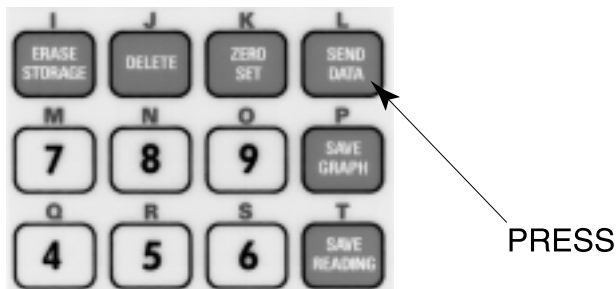

The “Send Data” key is used in conjunction with the Data Screen and Graph Screen to send stored data through the RS-232 Serial Port to external printers or computers.

6. USING THE SETUP SCREEN

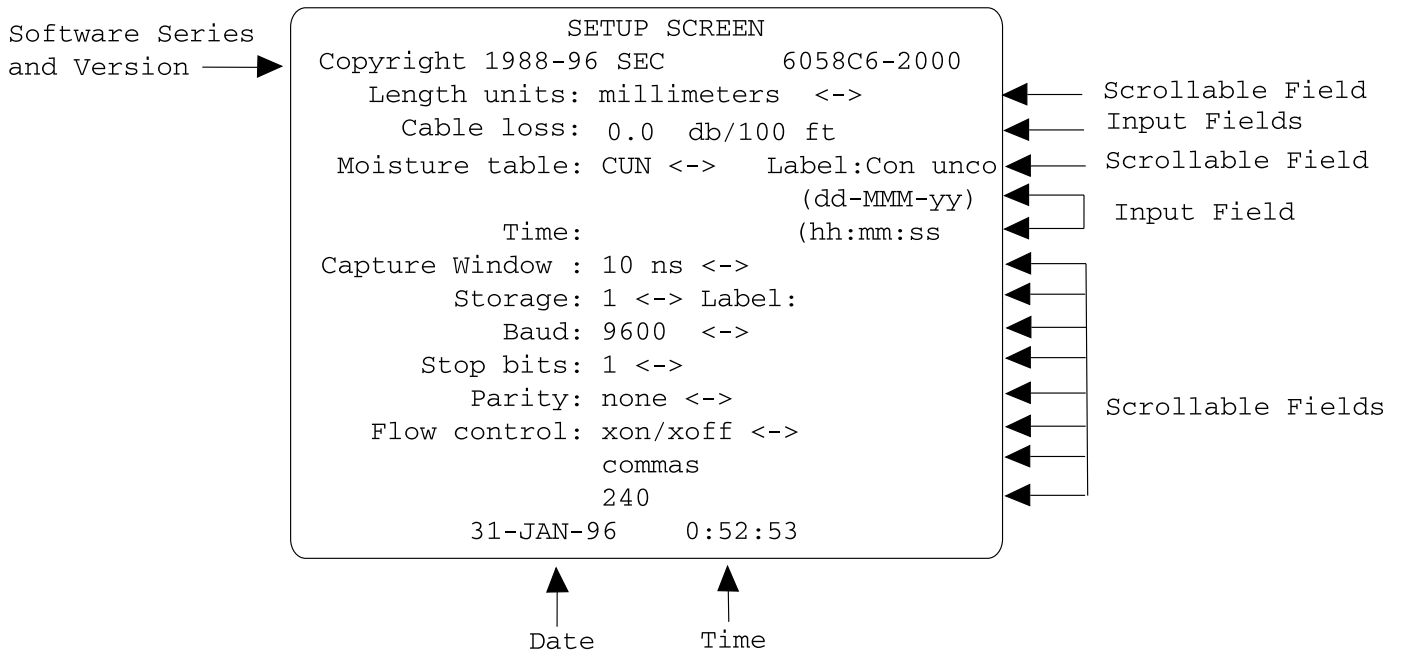

Before taking moisture readings it is necessary to set various internal operational parameters which are used in calculations and in the recording of data.

Call Up Setup Screen

First key to the Measure Screen, then press **SHIFT** key then press **NEXT SCREEN** key. If the incorrect screen appears repeat the process until the Setup Screen appears. The various screens appear in rotation.

Set The Length Units

Press **UP** key until cursor is on the arrow next to the “length units” field. Press **NO** key or **YES** key until the field scrolls to the desired unit. The choices are: millimeters, centimeters, inches, and feet.

The unit of length refers to the length of the Waveguides used in the moisture measuring process. The standard Waveguides supplied by Soilmoisture Equipment Corp. are all designated in centimeters. When using these Waveguides, the unit of length selected should be “centimeters”.

“Cable Loss” Value

After making your choice, exit the field by pressing the **UP** or **DOWN** key.

The next field is factory set at 4 dB/100 feet. You should not need to make any changes to this setting.



If you make a mistake during the entry, press  key and start over.

Example

October 17, 1995 would appear as 17-OCT-95.

Set The Time

When all entries are correct and complete, press  key. The date entered will now appear at the bottom of the screen and the “Date” field will be cleared.

Press the  key or the  to move the cursor to in the “Time” field.

TIME: (hh : mm : ss)

Press numeral keys corresponding to the hour on a 24 hour clock. Hours 1 through 9 would be keyed in as 01, 02, etc.

The cursor will then jump to the “minute” position.

Press numeral keys corresponding to the minute. Minutes 1 through 9 would be keyed in as 01, 02, etc.

The cursor will then jump to the “seconds” position.

Press numerals corresponding to seconds of time and then immediately press  key.

An alternate way of setting seconds is to simply press  key when seconds are zero.

Example



10:23 AM would appear as 10-23-00 and 10:23 PM would appear as 22-23-00.



The time entered will now appear at the bottom of the screen and will be updated every second.



When storing data, the correct date and time of the reading will now also be recorded along with the reading.

Set The Capture Window

The “Capture Window”, used to display graphs of the TDR Pulse, is described in “The Measurement System” in Section 2, “Principles and Techniques of Operation”. Refer to this section before making any adjustments on the length of the Capture Window.

The Capture Window length of 10 nanoseconds, which is used when working with short Waveguides of 15 or 30 cm length, has been set at the factory. To change the length, press  key or  key until the cursor is on the arrow next to the “Capture Window” field. You have a choice of 10, 20, or 40 nanoseconds, abbreviated as “ns”.

Press  key or  key until this field scrolls to the choice desired.



After making your choice, exit the field by pressing the  or  key.

Select and Label The Storage Areas



Data can be stored in any one of four separate storage areas. This provides flexibility in keeping one user's data separate from another user's or keeping data from one site separate from another, when required.

Each individual storage area is automatically expanded to accept the data being stored. The total memory for all areas combined, however, remains the same. In other words, if a large amount of data is being stored in one storage area, the amount of memory available for storing data in other areas is reduced.



If you wish to store all of your data in one storage area you may do so, and you will make use of the full memory capacity of Trase. If you wish to divide the storage into several storage areas you will have the same total storage capacity.

In the "Storage" field, you can scroll between areas 1,2,3, and 4. Press  or  key until the field scrolls to the number you desire.

Press  key and the cursor will move to the right into the "Label" field.

You can now enter up to eight digits or alpha characters to identify or "label" storage area 1. Press the numbered keys desired. To enter letters, first press the  key and then press the  key after entering the letter(s) desired.

After completing the "label" for storage area 1 press  key.

To label storage area 2, press  key. This will bring you back to the "Storage" field and the field will indicate "1". Press  key and scroll to the number 2.

Press  key and the cursor will again move to the "Label" field.

You can now enter up to an eight character alpha numeric "label" to identify storage area 2.

This process can then be repeated to "label" storage areas 3 and 4 if desired.

Set Data Transfer Parameters



The Setup Screen is used to set the parameters needed for the transfer of moisture readings and graphs to external printers or computers. For details on setting these parameters refer to Section 14, "Technical Interface Information".

Modem

The “Modem” field operates with our WinTrase Software to allow remote access of a Trase unit in the field from your home or office PC using a modem. If you do not have WinTrase Software, leave the field at the default setting of “none”. You may contact our Sales Department if you are interested in remotely accessing your Trase unit.

Set Auto Shutoff Time

The auto shutoff time of 120 seconds has been set at the factory. To change, press the  key until you are in the last field which is the “Auto shutoff time” field. You have a choice of 20, 60, 120, or 240 seconds.



Press  key or  key until you scroll to the desired choice.

Press  key.

The shortest auto shutoff time period, commensurate with the type of work being done, is desirable for conservation of battery power.

Press  key.



Adjust LCD Contrast

Press  key or  key to change LCD contrast to desired level, as noted at the bottom of the screen. Press  key to return to the Setup Screen.

Note

This adjustment can be made in any “help” screen.

Turn LCD Backlight On or Off

Press  key. Press  key. Repeated pressing turns backlight on and off. Press  key to return to Setup Screen.

Note

This adjustment can be made in any “help” screen.

Help Screen

For additional information on the use of this screen, press  key and follow instructions given on screen.

7. USING THE MEASURE SCREEN

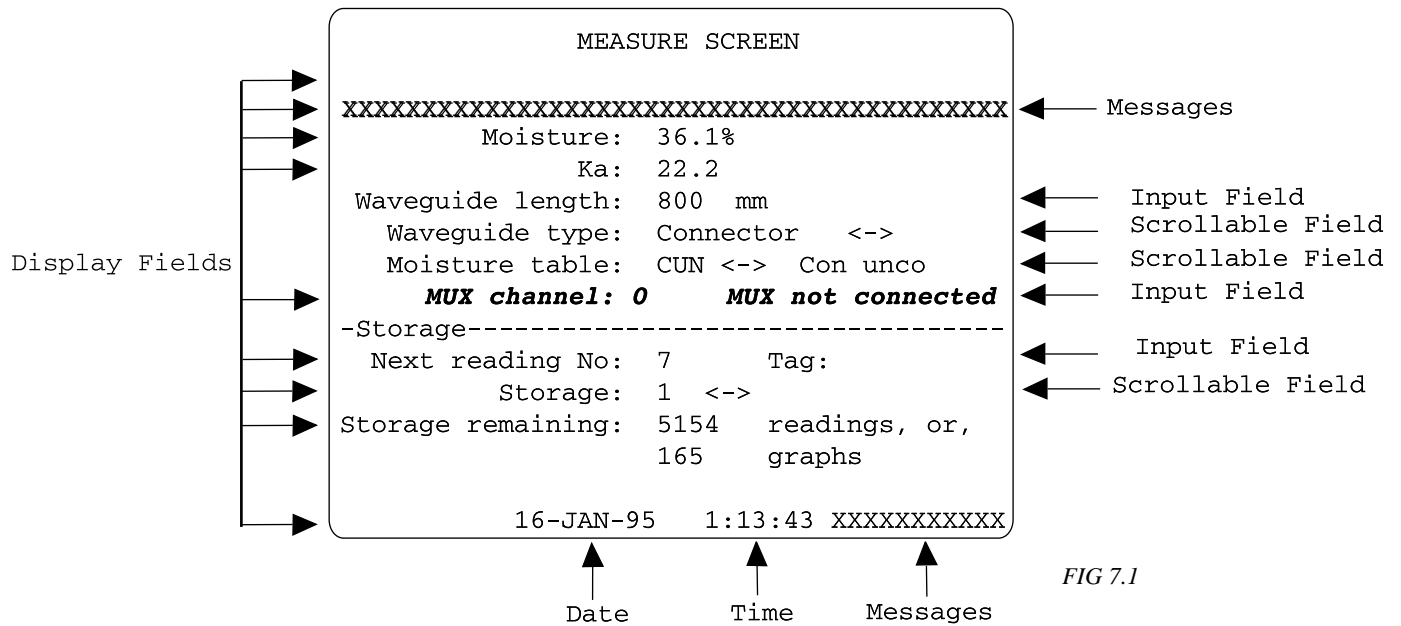



FIG 7.1

Call Up Screen

Key to the Measure Screen as follows:

Press  key.





If the Data Screen or Graph Screen appears, press  key once or twice until the Measure Screen appears. The Measure Screen, the Data Screen, and the Graph Screen appear in rotation.

Note

The “Mux channel” field, appears only if your Trase unit incorporates multiplexing capabilities. See Section 16, on “Multiplexing”.



You will be using the Measure Screen to make and store moisture readings.

Set The Waveguide Type

Press the  key or the  key until the cursor is on the < > next to the “Waveguide type” field. Use the  or the  to scroll among waveguide types. Trase System I can be operated with two types of waveguides.





The “connector” type of waveguides are used with our standard Model 6002 Waveguide Connector. This is a very sturdy, electronically “balanced” system used primarily for making measurements from the surface of the soil.

The “buriable” type of waveguides are designed to be buried in the soil for making moisture measurements at various horizons in the soil profile. They can also be used for light-duty measurements from the surface of the soil.

After bringing the cursor to the “waveguide type” field, press the  key or the  key to scroll between the type of waveguides to be used.

Set the Moisture Table

Four Standard Moisture Tables were installed at the factory. CUN: for Waveguide connectors with uncoated waveguide rods; CCT: for waveguide connectors with coated waveguide rods; BUN: for buriable waveguides with uncoated Waveguide rods; and BCT: for buriable waveguides with coated waveguide rods, and four Custom Moisture Tables for your own special use: T01, T02, T03, and T04. You must choose one of the four **Standard** Moisture Tables until there is a requirement for a Custom Moisture Table and such a table has been prepared and entered into your Trase unit. See Section 13 "Custom Lookup (Moisture) Tables" for further information on custom moisture tables.

To select a moisture table in the Measure Screen, press the  key or the  key until the cursor is on the arrow next to the “Moisture Table” field. Press the  key or the  key to scroll to the desired choice of moisture table.

Caution

If, for example, “CUN” is selected, moisture percent will be calculated from the Standard “Waveguide Connector - uncoated Waveguides” Moisture Table. If any of the custom “T” Moisture Tables are selected, moisture percent will be calculated from that particular Custom Moisture Table.

If one of the Custom Moisture Tables is selected, and a custom moisture table has not been entered into Trase, there will be no moisture percent calculated and all measurements will be displayed as 0.0%.

Making a Measurement with the Waveguide Connector

Select the “Connector” Waveguide type as indicated above.

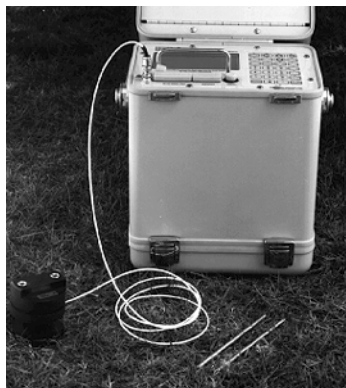

Attach the BNC fitting of the Waveguide Connector to the BNC Port on the Processor panel, as shown. Remove the Waveguides from the Connector and place the Connector upright on its clamping knob so that the Waveguide Sockets are in the air and not touching any object, as shown.

Before making a series of readings it is necessary to “zero set” the TDR Processor for the Waveguide Connector and cable to be used. This process establishes the zero time reference for the start of the microwave pulse down the waveguides.

Zero Set

To zero set, press the  key.

The process takes a number of seconds and during this time the message “Setting the Zero, wait...” will be displayed in the top left corner of the screen. When the process is complete, the message “Zero set” is displayed. During the zero setting process the “time” display is not updated. However, the correct time will again be displayed when the process is completed.

Note

The most common error during zero set is leaving the waveguides inserted in the waveguide connector. Remove the waveguides before zero set.

Mount Waveguides

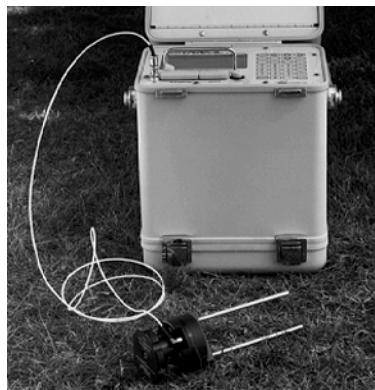

PHT 7.2

Insert in Soil

Insert the Waveguides in the Waveguide Connector, as shown. Be sure to mount them properly as described in “Waveguide Connector and Waveguides” in Section 3, “Acquaint Yourself With The Parts”.

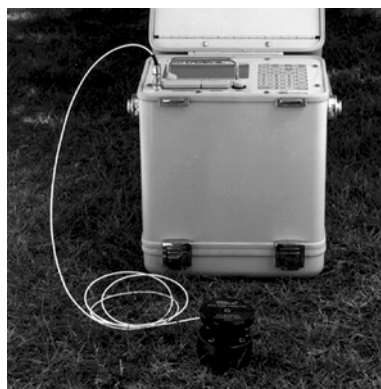

PHT 7.3

Push the Waveguides into the soil until their full length is in the soil, as shown.

Note

Waveguides must be in intimate contact with the soil along their entire length to give accurate moisture readings. Both the standard stainless steel or coated waveguides must be in intimate contact with the soil. Air gaps will be interpreted as air space and will reduce to estimated moisture content value.

Press the  key until the cursor is in the “Waveguide length” field, as shown.

Set Waveguide Length

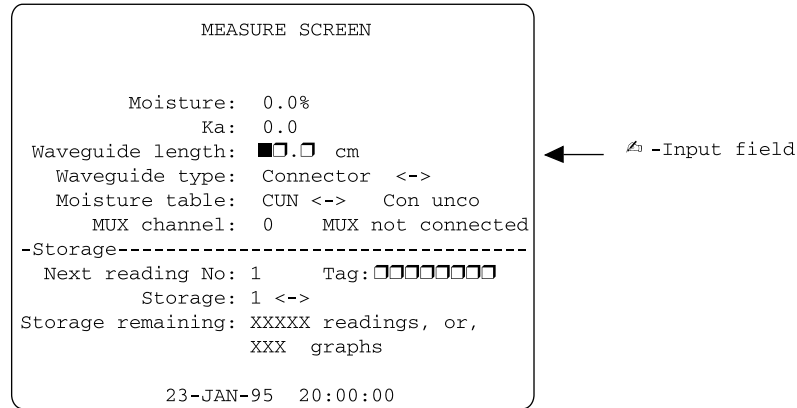

The unit of length you selected in the Setup Screen will be displayed. When using standard Soilmoisture Equipment Waveguides use “centimeter” units.

The standard Waveguides supplied with the instrument are designed to project 15 cm beyond the Waveguide Connector.

For the 15cm long Waveguides, the Waveguide length should now be entered into the Processor as follows:

Press the numeral **1** key, the **5** key, then the **•** key, next press the **0** key and finally the **ON ENTER** key.

If an error is made, **DELETE** press key and start over.

You can enter Waveguide lengths ranging from 15 cm to 70 cm or the equivalent length in other units of measure.

Note

If you enter a value of less than 15 cm, the message “Warning: Length < 15 cm reduces accuracy” will be displayed in the error message field. If you enter a value greater than 70 cm, the message “Warning: Length >70 cm may not measure” will be displayed in the error message field.

Make a Measurement

To start the measurement process, press the **MEASURE** key.

The process takes several seconds and during this time the message “Measuring...” will be displayed in the message field.

During the measuring process the “time” display is not updated. However, the correct time will again be displayed when the process is completed.

```

MEASURE SCREEN

MEASUREMENT COMPLETED
  Moisture: 27.0%
    Ka: 14.1
Waveguide length: 15.0 cm
  Waveguide type: Connector <->
  Moisture table: CUN <-> Con unco
    MUX channel: 0 MUX not connected
-Storage-----
  Next reading No: 2 Tag: rrrrrrrr
    Storage: 1 <->
Storage remaining: 5,124 readings, or,
                  162 graphs

23-JAN-95 20:00:00

```

When the measuring process is complete the volumetric moisture content along with the apparent dielectric constant of the soil, Ka, will be displayed, as shown.

Note



If you wish to relate Ka, the “Apparent” dielectric constant, to moisture percentage see FIG 2.1 & FIG 2.2 in Section 2, “Principles and Techniques of Operation”.



If you store the moisture reading, it is automatically identified by a storage area and a sequential reading number, starting with “1” for the first reading, within that storage area. The date and time the reading was taken is also automatically stored with the reading, as well as the Waveguide Length and Ka value.

The reading number displayed in the “Next Reading No.” display field is the number which will be assigned to the moisture reading if it is stored.

“Tag” Reading

The “Tag” input field is provided for you to further identify the reading such as the location where the reading was made or for other particulars associated with the reading. This is an 8 digit, alphanumeric string field.



To make the entry, press  key or  key until the cursor is in this field. Then press the numeral and alpha keys desired, and finally press the  key.

If you make a mistake, press  key and start over or you can press the  key repeatedly (first be sure you are not in “ALPHA” mode, otherwise you will enter letters) to delete the entry one character at a time, starting from the last character.

The “Tag” entered for this reading will now also be stored with the reading.

Store Reading

Before storing the moisture reading you must decide the storage area in which the reading will be stored. The “Storage” selection field scrolls through the numbers 1, 2, 3, and 4. The number shown, such as “1”, indicates the storage area currently designated to store the data. The default selection is “1”.

If you wish to change the storage area, press the  key until the cursor is on the arrow next to the “Storage” field. Press  key or  key to scroll to the numbered storage area desired. As you scroll from one storage area to another, the “Label” name you may have assigned to that storage area using the Setup Screen, will be displayed to the right of the storage area numbers. See “Using the setup screen”, Section 6-4.

To store the moisture reading together with its associated identification, press the  key. Immediately, the message “Reading Saved”, with date and time of storage, will be displayed in the message display field at the top of the screen.

To store the graph of the TDR pulse, together with the moisture reading and the associated identification, press the  key. Immediately, the message “Reading and Graph Saved”, with date and time of storage, will be displayed in the message display field.

When a moisture reading or graph of the TDR pulse is stored, the “Remaining Storage” display field is immediately updated showing the remaining readings and/or graphs that can now be stored.

The stored moisture readings can be reviewed and searched in the Data Screen. The Data Screen is also used to transfer stored readings to external printers or computers.

Note

If you did not enter data parameters correctly or completely, a warning message, “No reading taken reading/graph not saved” will appear at the top of the Graph Screen.

Use of Long Coaxial Cables and Cable Loss Settings

With the advent of our new and more powerful pulser, Trase is able to span greater distances. With special RG-58 type TDR cable, manufactured for and supplied by Soilmoisture, you get both low cost and low loss characteristics. This superior cable has less than 12db/100 ft @ 1Ghz, providing good pulse returns even in moist, minimal attenuative conditions. Soilmoisture recommends using our special RG-58 type cable to 150 ft. (45 meters) lengths. Should you be monitoring highly attenuative conditions in very moist soils, it is mandatory you use “coated” waveguides at all cable lengths. The dielectric coatings on the waveguides provide greater pulse reflections, an absolute necessity for longer distance TDR measurements. In dry conditions 0-10% moisture conditions, our standard Soilmoisture cable may be suitable to 200 ft. maximum provided you use coated Waveguides. In very moist and highly attenuative conditions beyond 150 ft. , in addition to using coated waveguides you may need to implement the heavy duty extremely low loss RG-8/U cable to assure an adequate return pulse.

For long length measurements beyond 100 ft. you may need to do some home-work. If possible, prototype a replicate of the actual conditions present, testing the cable and waveguide combinations with a Trase and/or MUX to insure that the actual full scale implementation will result in a successful and complete TDR gathering process.

Making a Measurement With The Buriable Waveguides

From the Measure Screen, select the “Buriable” waveguide type as indicated above.



The standard Model 6005L Buriable Waveguide and 6005CL Coated Buriable Waveguide are 20 cm long with a 2-meter cable attached. Extension cables for use with the Buriable Waveguides comes in a variety of lengths, up to 45 meters long. The Buriable Waveguide is designed to be buried permanently in the soil. The waveguides can be buried and accessed from a “rough and ready” stake out as shown to the more preferable practice of “sheathing” the cables in PVC tubing that in turn feed into a standard NEMA enclosure.

Note

Extension cables up to 45 meters are available. These are constructed of special Soilmoisture “low loss” RG-58 type cable. Please contact our Sales Department for further information.

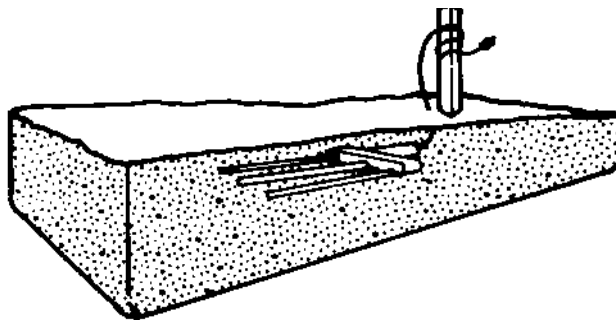

See Section 12, “Field Measurements”, for full information on installation of Buriable Waveguides.

When you are using the Buriable Waveguides the Zero Set process is not required as when using the Waveguide Connector. The Buriable Waveguide has a built-in electronic feature which the software recognizes for its computation of percent of moisture.

The waveguide length is automatically set at 20 cm by Trase, corresponding to the length of the standard Model 6005 Buriable Waveguide. If you are using a special Buriable Waveguide, with longer or shorter waveguides, the new waveguide length can be entered manually in place of the 20 cm length. Follow the procedure “Set Waveguide Length”, described under “Making a Measurement with the Waveguide Connector”, in this section.



CAP IN PLACE



CAP REMOVED

The BNC fitting on the cable of the Buriable Waveguide is protected by a soft plastic cap. The cap provides field protection for the BNC fitting from soil, water, and other contaminants.

To make a reading, remove the protective cap from the end of the BNC fitting, connect the fitting to the BNC Port on the Processor Panel of the TRASE unit and press the **MEASURE** key. The moisture % and Ka will be displayed. Be sure to replace cap after you are finished making readings to keep fittings clean.

Tag & Store Readings

Readings and/or the readings and graphs can be tagged and stored in the same manner as described under “Making a Measurement with the Waveguide Connector”.

For simplicity and low cost, the Model 6005 three-prong Buriable Waveguide operates on an “unbalanced” measuring circuit rather than the “balanced” circuit used by our Model 6002 Waveguide Connector using two parallel guides. A “V” dip electronic feature is incorporated into the design of the Buriable Waveguide for recognition in making moisture measurements.

Graphs Produced by Buriable Waveguides

Typical graphs produced with the Buriable Waveguide with 2 meter long connecting cable are as follows:

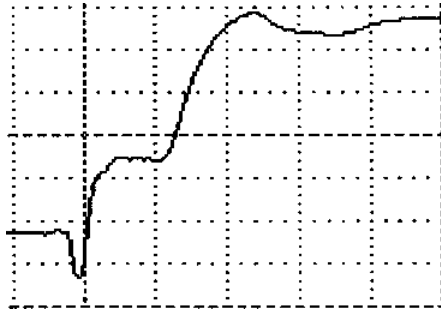

Sandy Loam Soil at 5% Volumetric
Moisture Content

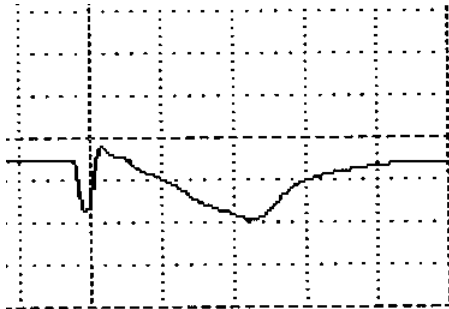

Sandy Loam Soil at 25% Volumetric
Moisture Content

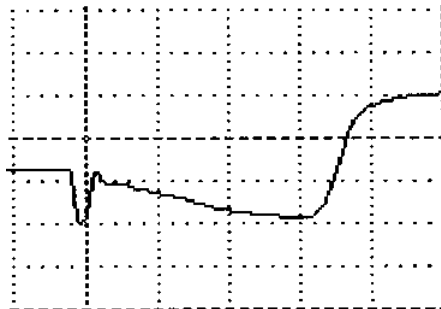

Clay Soil at 45% Volumetric Moisture
Content

The “V” dip feature can be seen at the left side of each graph. The bottom of the “V” corresponds approximately to the start of the pulse in the waveguides. The software always displays the graph so that the start of the pulse down the waveguides is at the first (heavy) broken vertical grid line.

Features of the graphs are similar to those as described in Section 2, “Principles and Techniques of Operation”.

SPECIAL MEASURING CONDITIONS

Measurements with Long Waveguides in Wet Soils

The measuring process makes use of a “Capture Window” in the determination of the moisture percentage. Detailed information on this is carried in the section “The Measurement System” under Section 2, “Principles and Techniques of Operation”.

When working with long Waveguides in wet soil it may be necessary to select a longer Capture Window in order to make the moisture reading. Selection of window length is made in the Setup Screen.

Measurements with Short Waveguides

Measurements can be made with Waveguides of less than 15 cm. However, the accuracy of the readings decrease as the waveguides get shorter because the “transit” time becomes small in relation to internal measurement variations.

Measurements in Saline Soils

Special coated waveguides for use in very conductive saline soils can be provided on custom order. These waveguides require the Standard Moisture Tables used for coated waveguides or your own special moisture tables. Contact us for further details.

Help Screen

For additional information on the use of this screen, press **HELP** key and follow instructions given on the screen.

8. USING THE DATA SCREEN

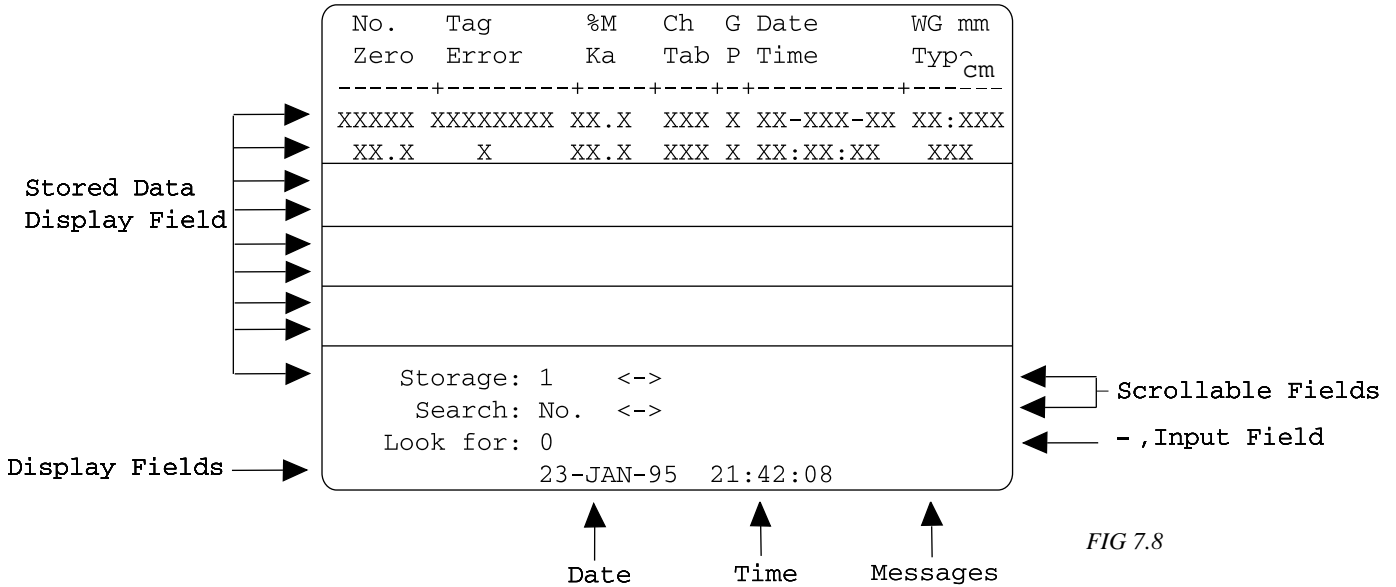

FIG 7.8

Call Up Screen

Key to the Data Screen as follows:

Press **ON ENTER** key.

If the Graph Screen or Measure Screen appears, press **NEXT SCREEN** key once or twice until the Data Screen appears. The Data Screen, Graph Screen, and Measure Screen appear in rotation.

Trase has substantial memory for the storage of data. The standard model will store at least 5,400 moisture readings or at least 173 graphs of the TDR pulse, or the equivalent combination of readings and graphs. The data is stored in up to four separately available storage areas. For any one storage area a “block” of up to 4 readings at a time are displayed. These are arranged in the order they were taken by reading number.

Screen Abbreviations

There are 14 “details” of measurement for each reading taken. To conserve screen space, these details are arranged in two rows of seven columns for each reading. The two top rows on the screen show the abbreviations used for the “details” reported below for each reading. From left to right, on the first row, the abbreviations are as follows:

“No.” This is the number of the reading, assigned in chronological order, by the Trase software.

“Tag” This is the identifying 8 digit alphanumeric code assigned by the user in the Measure Screen when making the reading.

“%M” This is the percent volumetric moisture content calculated for the reading.

“Ch” This is the “channel” number assigned to a specific Waveguide location when the Trase unit is equipped with multiplexing capability and is operating in that mode.

“G”	This is the “group” number reserved for other software enhancements involving extended multiplexing capability. Ask our Sales Dept. about Model 1800 Software.
“Date”	This is the “date” the reading was taken, automatically assigned by the Trase software.
“WG cm”	This is the “Waveguide” length used in making the measurement. The “cm” indicates that centimeters were chosen in the Setup Screen as the “length unit”. If another length unit, such as inches, was chosen, then the abbreviation “in” would be displayed in place of the “cm”.



From left to right, on the second row, the abbreviations are as follows:

“Zero”	This is the time in nanoseconds from the “start of timing” until the pulse reaches the top, or beginning, of the waveguides.
“Error”	If there were problems with the measurement, an error code is displayed here. The various error codes and their meaning are covered later in this section.
"Ka"	This is the value of the dielectric constant calculated for this reading.
“Tab”	This indicates the Moisture “Table” used for the moisture calculation. For example, “BUN” appears for the Burable - uncoated moisture table.
“P”	This indicates whether a graph has been stored along with the reading. If a graph has been stored, the window size used in the measurement is displayed. A “1” displayed here indicates a 10 nS window; a “2” indicates a 20 nS window; and a “4” indicates a 40 nS window. If no graph is stored, an “N” is displayed.
“Time”	This is the “time” the reading was taken, automatically assigned by the Trase software.
“Type”	This indicates the type of Waveguides used for the measurement. BUN Burable Waveguide, Uncoated BCT Burable Waveguide, Coated CUN Connector Waveguide, waveguide sets uncoated CCT Connector Waveguide, waveguide sets coated T01...T04 Custom Lookup Tables; Table 1 through Table 4

Scroll Through Data

Convenient scroll and search features allow you to review the data efficiently.

If the cursor is not in the Stored Data Display Field (see FIG 7.8 on page 8-1), press  key until cursor is in this field in line with any reading number.

To review the “block” of readings (with lower reading numbers), preceding the block being displayed, press the  key and then press the  key.



Repeated pressing of only the  key will scroll up through the readings, four readings at a time.



While in this mode the “SHIFT” code will be displayed in the lower left corner of the screen.



To scroll down (to higher reading numbers) through the stored readings, follow the same general procedure, but press the  key.

Retrieve Stored Data

If the cursor is in the Stored Data Display Field, press the  key. This will bring the cursor immediately to the “Storage” selection field. If the cursor is below the “Storage” selection field, press the  key until cursor is on the arrow next to this field.

To review the data stored in another storage area, press  key or  key to scroll to the numbered storage area desired. The “Storage” selection field scrolls through fields 1, 2, 3, and 4 and repeats. Select the storage area desired.

Press  key or  key until the cursor is in the “Search” category selection field. The cursor should be within the selection brackets < > next to the “Search” category.

The “Search” field scrolls through the categories “No.,” “Tag”, and “Date”. To change search category, press  key or  key to scroll to the category desired.

To search for a particular reading number, select the “No.” category.

To search for a particular tag identification, select the “Tag” category.

To search for a specific date, select the “Date” category.

After making a selection, press  key to bring the cursor to the “Look for” input field.

Press the appropriate alphanumeric keys corresponding to the moisture reading desired. Dates must be entered in strict conformance to the pattern described under “Using the Setup Screen”.

After keying in the entry, press  key.

The moisture reading corresponding to the number, tag, or data requested will be displayed at the top of the stored data display field.



If an invalid date is entered, the message “NOT VALID” will flash in the lower right corner of the screen. When this occurs, review the date entry requirements described under “Using the Setup Screen”. Then reenter the date properly and

press  key.

If the entry cannot be found, the message “NOT FOUND” will flash in the lower right corner of the screen.

When this occurs review the entry, which is still displayed, to see if it is correct.

If it is incorrect, key in the correct entry and press the  key.

When the cursor is in the stored data display field it can be moved to any reading by pressing the  key or  key. Moisture readings that are associated with a graph of the TDR pulse are displayed with a number 10, 20, or 40 in the “P” field. Readings with no associated graph display an “N” in the “P” field.

To display the graph of the TDR pulse, move the cursor to the reading number that

you want displayed, then press the  key.

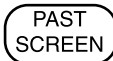
The graph selected will be displayed on the Graph Screen. To return to the Data Screen, press the  key.



Erase Stored Data

When a data storage area becomes full, or when the stored data is no longer needed, it can be erased. For safety reasons, this is a two-step process. The complete contents of any one storage area are erased at a time.

To erase the contents of a storage area, key to the Data Screen and then key the cursor to the “Storage” selection field in the Data Screen. Then press the 

key or  to scroll to the storage area number you wish to erase.

Press the  key. The message “YES OR NO” is displayed in the error message field in the lower right corner of the screen.





Press the  key if you want the stored data erased. Press the  key, if you do not want the data erased.

When the “YES” key is pressed, the data is immediately erased and the message “ERASED” is displayed in the lower right hand corner of the screen. The erasing process removes all stored data, including stored graphs.

When the “NO” key is pressed, it aborts the erase sequence and the message “NOT ERASED” is displayed in the lower right-hand corner of the screen.

The above process must be repeated for each storage area to be erased.

Use Cursor To Pick Graph For Display

When the cursor is in the stored data display field it can be moved to any reading by pressing the  key or  key. Moisture readings that are associated with a graph of the TDR pulse are displayed with a number 10, 20 or 40 in the “p” field. Readings with no associated graph display an “N” in the field. To display the graph of the TDR pulse, move the cursor to the reading number that you want displayed, then press the  key. The graph selected will be displayed on the Graph Screen. To return to the Data Screen, press the  key.

Transfer Stored Data

The stored data in any given storage area can be transferred to an external printer or computer. The RS-232 Serial Port on the control panel is used for this purpose. For details on the procedure, refer to Section 13, “Technical Interface Information”.

Message Symbols

If a problem was encountered in making a measurement, one of the following symbols will be displayed in line with the reading in the “error” column to indicate the nature of the problem, as itemized below:

“Meas err”	Measurement failed
“No graph”	Not enough memory to store graph
“Low batt”	Low Battery
“No zero”	Zero not set
“No WG ln”	Waveguide length not set
“Trap err”	Trap set failed

These symbols can be of particular value during Autologging operations.

Help Screen

For additional information on the use of this screen, press  key and follow instructions given on the screen.

9. USING THE GRAPH SCREEN

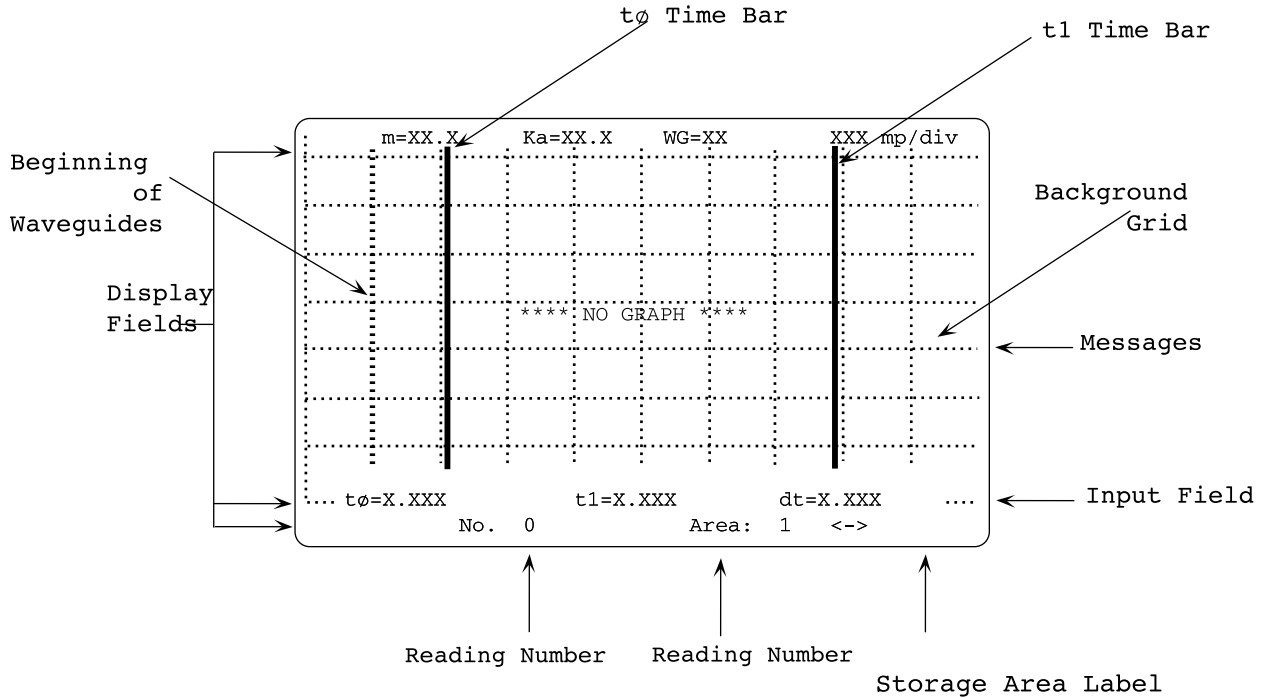

Note: The number of x's indicates numeric field sizes.

Call Up Screen

Key to the Graph Screen as follows:

Press **ON ENTER** key.

If the Measure Screen or Data Screen appears, press **NEXT SCREEN** key once or twice until the Graph Screen appears. The Graph Screen, Measure Screen, and Data Screen appear in rotation. Or, alternatively press **PAST SCREEN** from the Measure Screen to arrive at the Graph Screen





Select A Graph For Display

Graphs that have been stored can be selected for display from either the Data Screen or the Graph Screen. Select the storage area and the number of the moisture reading containing a graph directly or by selecting it in the Data Screen prior. Remember any reading displaying an "N" in the "P" category contains NO GRAPH. Enter the selected Storage Area and Reading Number directly in the Graph Screen and push **ON ENTER** to display the reading graph. Should the reading not contain an associated graph, a "NO GRAPH" will be displayed across the Graph Screen as shown in fig. 9.1

Select From The Graph Screen

To make your selection directly from the Graph Screen, press the **DOWN** key or the **UP** key until the cursor is on the arrow next to the "Area" selection field. Press the **YES** key or **NO** key to scroll to the storage area desired. The

“label” assigned to the particular storage area in the Setup Screen will be displayed for the storage area that is accessed.

To enter the number of the moisture reading , press the  or  key until the cursor is in the “No.” field. Then key in the numeral keys corresponding to the number of the reading required and press  key. If you make a mistake, press  key and reenter.

Immediately the graph of the TDR pulse, corresponding to the moisture reading entered, is plotted on the screen. At the top of the screen, in the moisture data display field, the % of moisture, the Ka value, the waveguide lengths, and the Y axis scale associated with that particular moisture reading are displayed.

You can display other graphs stored in the same storage area simply by keying in the moisture reading numbers and pressing the  key.



Select From The Data Screens

To make your selection from the Data Screen, press  key to bring up the Data Screen, and then follow instructions given under “USE CURSOR TO PICK GRAPH FOR DISPLAY” in Section 8 of these instructions.

Review A Graph Before Storage

When making a moisture reading you can review the graph of the TDR pulse to determine whether you wish to store it. Each time you make a moisture reading the graph of the TDR pulse is temporarily stored in the process of calculating the moisture percentage. The graph remains temporarily stored until you make the next reading.



After making a moisture measurement in the Measure Screen, press the  key to go immediately to the Graph Screen. The graph associated with the last reading taken will be plotted when 0 is entered in the “No. ”field.

If you now wish to store this graph, press the  key to return to the Measure Screen and press the  key as described under “STORE READING” in Section 7 of these instructions.





“No Graph” Message





When a moisture reading number in the “No.” field of the Graph Screen for which there is no stored graph and the  key is pressed, the message “NO GRAPH” will be displayed in place of the graph.

Operate The Time Bars

Two “Time Bars” are provided in the Graph Screen for convenience in measuring the time between different features on the graph of the TDR pulse. Movement of these bars is controlled by the  key and the  key.

The t_0 Time Bar is used to set the time reference for features at the beginning of the graph and the t_1 Time Bar is used to set the time reference for the pulse reflection off the end of the waveguides. See “Principles & Techniques of Operation” Section 2.

To move the t_0 Time Bar, press the  key or the  key until the cursor is in the t_0 time display field. Then press the  key or the  key to move the Time Bar in the direction desired. Pressing the key continuously causes the Time Bar to move at a maximum rate.

To move the t_1 Time Bar press the  key or the  key until the cursor is in the t_1 time display field. Then press the  key or the  key to move the Time Bar, as indicated above.

The Time Bar, to will not overlap the t_1 and vice-versa.

Note

The Time Bars appear in the last position set you have set .

The Graph Screen has a background grid that is a very accurate time reference.

The Time Reference Grid

The broken vertical grid lines divide the width of the screen or “Time Window” into 10 equal parts. The Time Window is explained under the section “The Measurement System” in Section 2, “Principles and Techniques of Operation”. The width of the Time Window set at the factory is 10.00 nanoseconds (a nanosecond is 1 billionth of a second, and is abbreviated as nS). The time between each vertical line is therefore 1.00 nS.

The first broken vertical grid line on the left is heavier than the other lines in the grid and easily distinguishable. When making moisture measurements, the Trase software displays the waveform, where the pulse enters the waveguide.

The horizontal broken background lines provide a reference for comparing energy levels as the pulse travels along the waveguides.

The spacing between horizontal lines is measured in millirhos, abbreviated mp, and is automatically scaled by Trase software. This is only an approximate value and is displayed for your convenience.

Since the strength of the return signal varies considerably depending on a number of factors, such as length of cable used, the Trase software was configured to amplify the signal so the displayed graph would be as large as possible to fill the screen. This automatic feature provides great operator convenience. For each graph displayed, the approximate number of mp per division between the two horizontal lines, is displayed in the upper right hand corner of the screen.

To obtain extremely accurate Millirho measurements it is suggested that a “reference cable to short” millirho scale be obtained using the same cables and multiplexer arrangements shorting the cable end. The scale is arrived at by taking the average incoming cable level in A/D values and the average short signal level in A/D values. If the average cable level input was A/D=2120 and the

average short level A/D=120, a difference of 2000 A/D is arrived at. Relative reflectance can then be determined precisely by taking a reflectance level in A/D values, for example 1567 A/D, and determining the exact ratio $1567/2000 = .7835 \times 1000$.

To obtain our “cable to short” Millirho factor, you will need to cause a short using your current cables and Multiplexer arrangements. It will be necessary to make an electrical short at the very end of the cable. The “short” scale factor is arrived at by taking the average incoming cable signal level in A/D values (associated with Trase Graphs) and the average short signal level in A/D values. If, for instance, the average cable level input was A/D = 2120 and the average short level A/D = 120, the difference would be 2000 A/D. Relative reflectance can then be determined precisely by taking a return reflectance level in A/D, for example 1567 A/D, and using the “shorting” factor $1567/2000 = .7835$, to determine the exact Millirho value $(.7834 \times 1000) = 7834$. Since this is a negative going signal level compared to the cable value it would be considered -7834 Millirho.

To obtain the factor for those reflective values that occur at higher values than cable values, in our example an A/D value of 2121 or greater, the “cable to open” scale factor is determined by allowing an electrical “open” at the very end of the cable. In this type of condition, we may achieve an average A/D value of, say, 3920. As before, the cable value is subtracted from the open value, in our example $3920 - 2120 = 1800$. If we now measure a dry material and find the average A/D reflectance value 3220, some 1100 A/D values above the cable value, the “open” factor would be $1100/1800 = .6111$; or an exact Millirho value of $(.6111 \times 1000) = 6111$ Millirho.

Measure Time With The Time Bars

The Time Window has three available widths, namely 10 nS, 20 nS, or 40 nS that the user can select. If the Time Window is changed to 20 nS, then the spacing between the vertical grid lines is 2 nS per division. Likewise, if the Time Window is changed to 40 nS, then the spacing between the lines is 4 nS per division.

When making moisture measurements, no matter what choice of Time Window is made, that portion of the TDR waveform that represents the start of the pulse down the Waveguides is always aligned to the first heavy broken vertical grid line.

When a moisture measurement is made, a fast rise pulse of microwave energy, generated by Trase, is sent down the connecting cable to the Waveguides buried in the soil. This pulse of energy is referred to as the “incident pulse”. Time measurements that are displayed on the Graph Screen begin at the “Start of Timing”. The incident pulse occurs several nanoseconds after timing starts. See the section “The Measurement System” under Section 2, “Principles and Techniques of Operation” for details.

When reviewing graphs associated with moisture measurements and making independent time measurements on the graphs, the heavy vertical grid line represents the beginning of the Waveguide and is a zero reference for the time required for the pulse to move down the Waveguides.

The t_0 time display field continuously displays the time in nanoseconds from the “Start of Timing” to the position of the t_0 Time Bar.

Similarly the t1 time display field continuously displays the time in nanoseconds from the “Start of Timing” to the position of the t1 Time Bar.

The dt time display field continuously displays the time between the t0 Time Bar and the t1 Time Bar.

To measure the time required for the pulse to move down the Waveguides, key the t0 Time Bar until it is directly over the heavy vertical grid line. This corresponds to the top or start of the Waveguides.

Then key the t1 Time Bar to the desired point on the graph at the point of reflection at the end of the Waveguide. The dt time display field will show the time required for the pulse to move from the start of the Waveguide at t0 to the feature on the graph where the t1 Time Bar is located.

Section 2, “Principles and Techniques of Operation”, gives detailed information on the interpretation of features on the graph and the manner in which the volumetric moisture percent can be determined from the graph.

Transfer Stored Graphs

The y coordinates of the graph being displayed can be transferred to an external printer or computer. The RS-232 Serial Port on the control panel is used for this purpose. For details on the procedure, refer to Section 14, “Technical Interface Information”.

Help Screen

For additional information on the use of this screen, press **HELP** key and follow instructions given on the screen.

10. USING THE AUTOLOG SCREEN

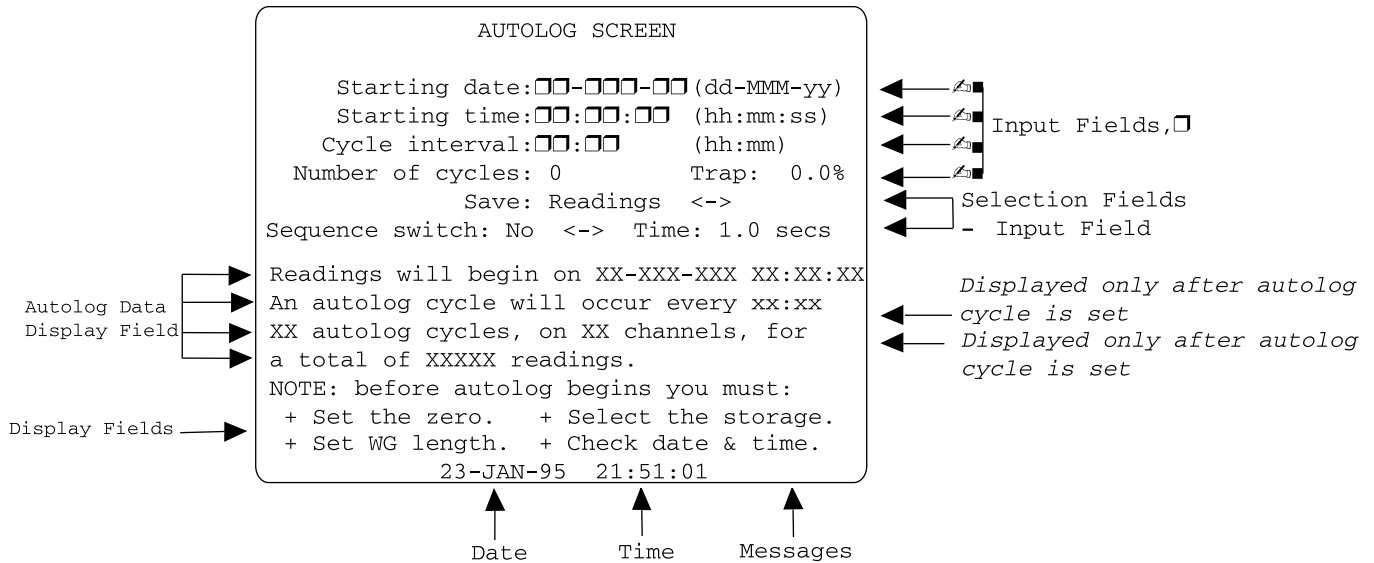

Note: The number of "□" indicates the size of the Input field
 The number of "X" indicates the size of the Display field

The Autolog Screen allows you to program when to start a series of moisture readings, the time interval between readings, and the total number of readings to be taken. You can store just the reading or the reading and the graph associated with the reading.

Be sure the battery is fully charged before starting an autolog series of measurements. See Section 4, "Requirements Prior to Use" for detailed information on checking and charging the battery.

Call Up Screen

Key to the Autolog Screen as follows:

Press **ON ENTER** key.

If the Graph Screen or Data Screen appears, press **NEXT SCREEN** key once or twice until the Measure Screen appears. The Graph Screen, Measure Screen, and the Data Screen appear in rotation.

The Autolog Screen is accessed directly from the Measure Screen by pressing the

SAVE GRAPH key and then the **NEXT SCREEN** key.

Set Starting Date

When you key to the Autolog Screen, the cursor automatically defaults to the Starting Date input field. Key in day of the month, the abbreviation of the month, and the last two digits of the year in strict conformance to the pattern described under Section 6, "Using the Setup Screen".

After keying in the entry, press **ON ENTER** key. The date keyed in will now be displayed in the Autolog Data Display field. Trase will automatically switch between ALPHA and NUMERIC modes when entering the date, month, and year.

Invalid entries will cause the error message “NOT VALID” to flash in the lower right corner of the screen. Press the Delete key to reenter correct data.

Set Starting Time

To set the starting time, press the  key to bring the cursor in the Starting Time input field. Key in the hour, minute, and second when readings are to start in conformance to the pattern described under Section 6, “Using the Setup Screen”.

After keying in the entry, press  key.

The time keyed in will now be displayed in the Autolog Data Display field. Invalid entries will cause the error message “NOT VALID” to flash in the lower right corner of the screen. Press the Delete key to reenter correct time.

Set Interval

To set the time between readings, when using a single set of Waveguides or time between readings when using multiple waveguides in a multiplexer array, press the  key to bring the cursor in the Cycle Interval input field.

Key in the hours and/or minutes desired between readings in conformance to the pattern described under Section 6, “Using the Setup Screen”. A minimum interval of 1 minute or a maximum interval of 23 hours and 59 minutes can be entered.

After keying in the entry, press  key.

The interval entered will now be displayed in the Autolog Data Display field.

Set Number Of Cycles

To set the number of reading cycles, press the  key to bring the cursor to the Number of Cycles field.

Note

Key in the number of cycles required, however, be sure that the total number of readings to be made does not exceed the “Storage Remaining” as displayed on the Measure Screen.

After keying in the entry, press  key.

The number of cycles keyed in will now be displayed in the Autolog Data Display field.

The Trap Percentage Field

The “Trap Percentage” field is used for troubleshooting purposes only. Its use is covered in Section 14, “Maintenance and Troubleshooting”.

Select Readings Or Graphs

To select whether Readings Only or Graphs and Readings will be stored, press the  key to bring the cursor to the arrow next to the “Save” selection field.

This selection field scrolls between “Readings” and “Graphs”.

To change the category, press  key or  key to select the category desired.

Caution

The storage of graphs requires considerable memory. Make sure your proposed Autolog program does not exceed the “storage remaining” as displayed on the Measure Screen.

Prepare Connections For Series Of Reading Cycles

After completing the entries in the Autolog Screen, press  key to go directly to the Measure Screen.

The Information display field will now show the message “AUTOLOG ACTIVE”. Be sure to follow instructions at the bottom of the Autolog Screen before autologging begins.

Note

If the Waveguide connector is used in AUTOLOG, attach the Waveguide Connector, “Zero Set” the TDR processor, enter the Waveguide length, and insert the Waveguides in the soil as described under Section 7, “Using the Measure Screen”.

If Buriable Waveguides are used it is not necessary to “Zero Set” the TDR processor.

The reading series will now start as programmed.

Accessory items are available to bring the Waveguide Connector cable and auxiliary power through the Trase Cover when required to seal against the environment. See Section 12, “Field Measurements”.

To Abort The Autolog Cycle

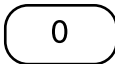
To abort the Autolog Series of readings at any time, key to the Autolog Screen, key the cursor to the “Number of Cycles” input field, and press the  key. Entering “0” cycles nullifies the program. All stored readings are retained.





Note

The “Starting Date” and other measurements parameters, originally entered, will be displayed on the Autolog Screen until new or modified entries are made. This feature provides a record of the Autolog sequence and minimizes entry requirements when similar sequences are used.

Apply The Sequence Switch

The Autolog Screen controls a “Sequence Switch” which is activated momentarily immediately after each reading is made when autologging a series of readings. The Sequence Switch is activated for a set interval of time ranging from .1 second to 9.9 seconds. Connection to the switch is made through the Multiplex Port as covered in the section, “Multiplex Port Pin Assignments”, under Section 13, “Technical Interface Information”.

The purpose of the Sequence Switch is to sequence or control external devices which may be involved in the measuring process. It can also be used to coordinate the moisture measurement to the measurement of other physical properties with other external devices.

To engage the Sequence Switch, press the  or  key to bring the cursor to the arrow next to the “Sequence Switch” field. This selection field scrolls between “ON” and “OFF”. The default setting is “OFF”. To turn the Sequence Switch “ON” or “OFF”, press  key or  key.

To set the time interval that the Sequence Switch is activated, press the  key to bring the cursor to the “Time” field. Key in the number of seconds desired from .1 second to 9.9 seconds.

After keying in the entry, press  key.

Electrical connections can now be made through the Multiplex Port to coordinate external equipment to each Autolog reading that is made.

Caution

Manual operation of Trase, using the Measure Screen, overrides the Autolog cycle. Using the Measure Screen while Trase is autologging may interfere with Trase’s ability to make proper autolog readings.

Autologging With The Multiplexer

If your Trase unit incorporates multiplexing capabilities, there are additional instructions for preparing connections and operation of your unit. See Section 16 on Multiplexing.

Help Screen

For additional information on the use of this screen, press  key and follow instructions given on the screen.

11. USING THE TDR SCREEN

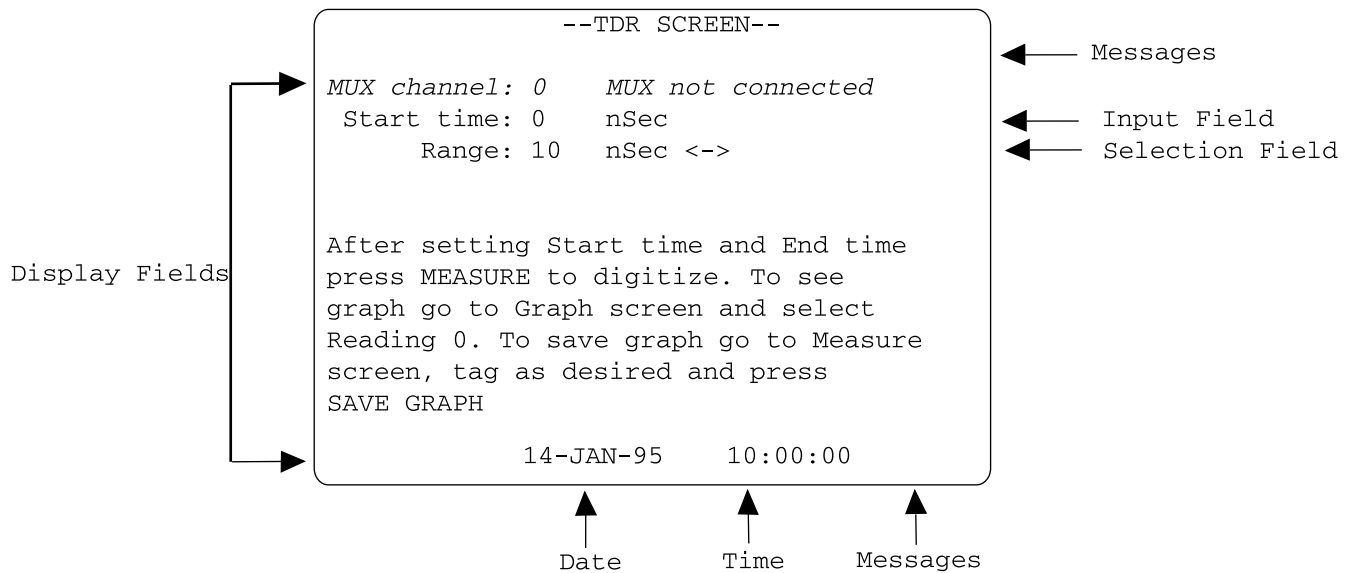

The TDR Screen provides capabilities similar to a cable tester that can be used to check the continuity of connecting cables and to isolate breaks or discontinuities in cables.

The TDR Screen also provides the means of making measurements with all types of specialized waveguides and displaying the resultant graph of the TDR pulse on the Graph Screen where time measurements can be made.

When making measurements in the TDR Screen the times entered are measured from the system "start of timing".

Call Up Screen

Key to the TDR Screen as follows:

Press key.

If the Measure Screen does not appear, press key once or twice until it appears. The Data Screen, Graph Screen, and Measure Screen appear in rotation.

The TDR Screen is accessed directly from the Measure Screen by pressing

the key and then the key and then again the key and the key.

Note

The "Mux channel" field, shown in italic face, appears only if your Trase unit incorporates multiplexing capabilities. If your Trase unit is connected to your assembled Multiplexer enclosure it will read "Mux connected". If no connection has been established, it will read "Mux not connected". See Section 16 on Multiplexing.

Relationship of Time and Cable Length

The pulse of microwave energy, generated by Trase, travels in the coaxial cable and in the Waveguides at approximately the speed of light. The speed of light is 3×10^{10} cm per second or 30 cm per nanosecond (a nanosecond is 1 billionth of a second). The speed in the cable depends also on the dielectric constant of the materials used in the construction of the cable. The “velocity of propagation” in the average coaxial cable is actually about 70% of the speed of light.

The “velocity of propagation”, or “Vp” as it is abbreviated, is available for different types of coaxial cable. Multiplying the Vp of the cable by the speed of light gives the speed that the pulse will travel in the cable. The coaxial cable, such as used in the Trase connecting cables, has a Vp of approximately .70. This means that in 1 nanosecond the pulse will travel (.70)(30 cm), or 21 cm, or about 8 inches down the cable.

The above relationship between nanoseconds of time and length of cable can be used in estimating the “Start time” and the “Range” to be entered in the TDR screen.

Setting the Start Time and Range

The section “The Measurement System” in Section 2, “Principles of Techniques of Operation” explains the manner in which the graph of the TDR pulse is created and describes the “Capture Window” in which it is displayed.

The graphs of the TDR pulse made from measurements in the TDR Screen are displayed in the Graph Screen. The “Start time” entered corresponds to the left side of the Graph Screen and the “Range” corresponds to the desired time range to be examined.

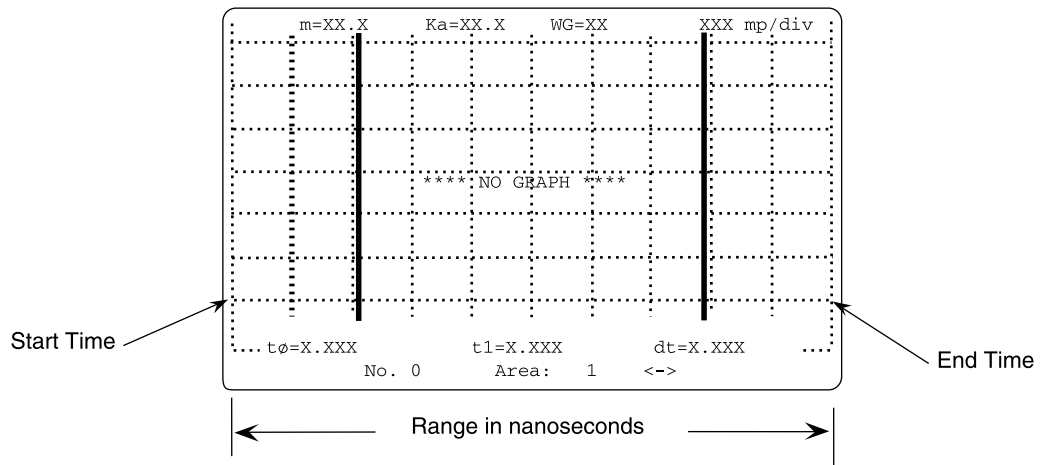

The width of the screen will then correspond, in nanoseconds, to the “Range” specified.

Large Capture Window

If a “Start Time” of 0 nS (abbreviation for nanoseconds) is entered and a “Range” of 100 nS were entered, then the width of the Graph Screen is 100 nS, and events from the “Start of Timing” to 100 nS after the “Start of Timing” count are displayed.

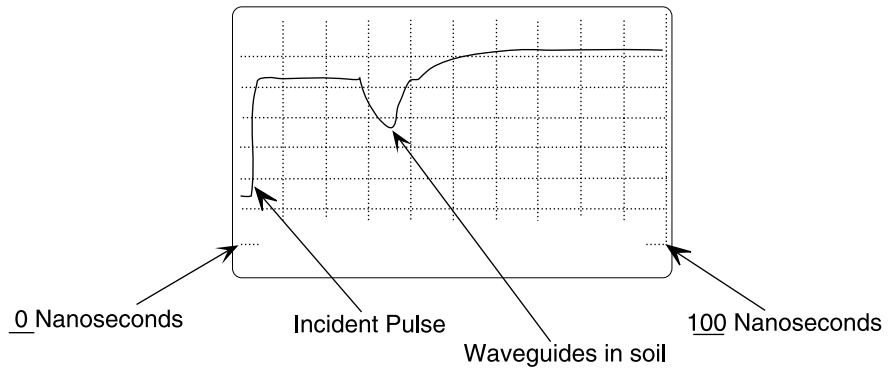

Small Capture Window

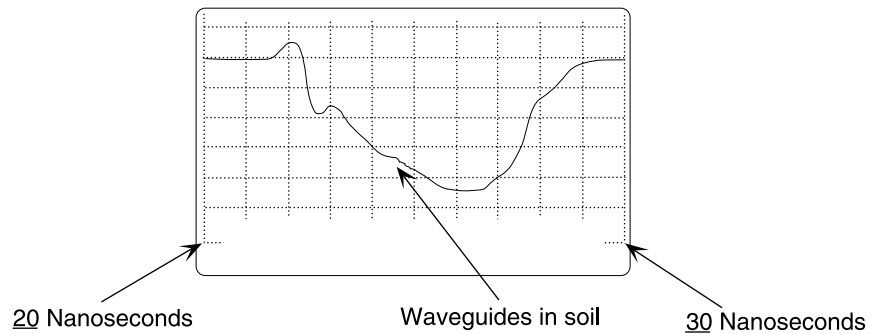

If, in contrast, a “Start Time” of 20 nS is entered and a “Range” of 10 nS is entered, then the width of the Graph Screen is 10 nS, and only events that occurred between 20 nS and 30 nS after the “Start of Timing” are displayed.





You may select 10, 20, 40, 80, 160, or 320 nS for the “Range” values. The total of the Start Time and Range cannot exceed 610 nS.

The flexibility of the TDR Screen makes it possible to look at the continuity of long connecting cables.

Making a TDR Measurement

Press the  key until the cursor is in the “Start Time” field. Enter the nanoseconds desired and press the  key.

Press the  key to bring the cursor to the “Range” field. Scroll to the capture window & nanoseconds desired and press the  key.

Press the  key to initiate the measurement.

During the measuring process the message “Digitizing...” will flash in the top left corner of the screen.

After the measurement is completed, the Graph Screen is automatically displayed.

The Time Bars can now be used to locate features on the graph, as explained in Section 9, “Using the Graph Screen”. The t_0 and t_1 , displayed in nanoseconds on the Graph Screen, can be converted to centimeters or feet, as outlined above, when troubleshooting connecting cables.

The graph of the TDR pulse, made from the TDR Screen, can also be stored. To do so, key to the Measure Screen before the next reading is made. “Tag” the reading, if desired, as covered under Section 7, “Using the Measure Screen”, and then store the graph in any storage area as described under the same section.

Finding Cable Breaks

When looking for cable breaks it is advisable to set the “Start Time” at 0 nSec. With reference to the relationship of time and cable length, the “Range” can be set so that it covers the entire length of the cable used. In this way, the graph will display the position of a break in the cable.

The screen below displays a typical graph showing a cable break.

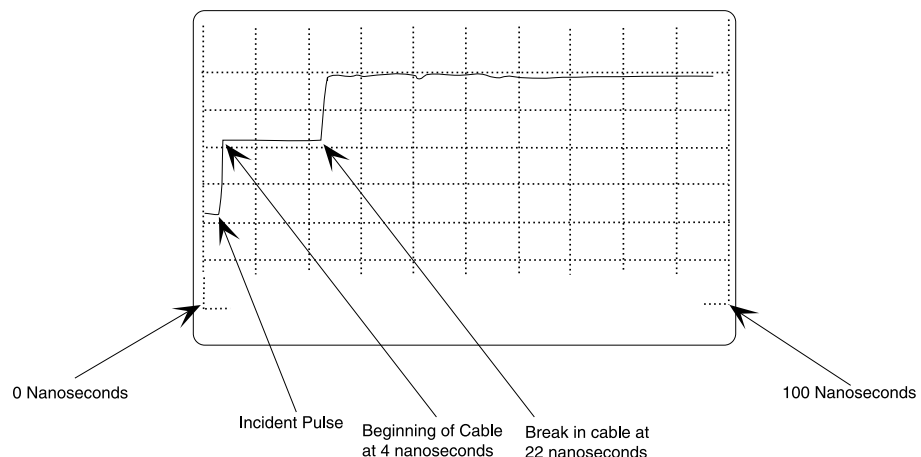

With reference to the graph, the beginning of the cable is at 4 nS and the break is at 22 nS. This means that the break is $(18 \text{ nS}) \times (8 \text{ inches/nS}) = 144 \text{ inches}$ from the beginning of the cable. In practice, using the Graph Screen, you would set the t_0 time bar at the position corresponding to the beginning of the cable and the t_1

time bar at the position of the break in the cable. The time difference would then be displayed in the dt time display field of the Graph Screen. This time value can then be readily converted to distance.

Help Screen

For additional information on the use of this screen, press  key and follow instructions given on screen.

12. FIELD MEASUREMENTS

12-A. Field Measurements Using the Standard Waveguide Connector

Insertion In Loose, Friable And Wet Soils

Using Short Waveguides in Spot Measurements

The standard Waveguide Connector and Waveguides, in conjunction with accessory items, are capable of measuring moisture in virtually all types of soils.

When the soil can be readily penetrated, the measuring Waveguides, are commonly 15 cm, 30 cm or 45 cm long. After “zero setting”, mount the Waveguides in the connector and insert the Waveguides in the soil. Always make sure that the Waveguides are fully inserted in the soil to obtain an accurate moisture measurement.



The Waveguide Connector is ruggedly built and considerable force can be used to push the Waveguides into the soil.

Caution

Do not hammer or stamp on the Connector since sharp blows can disturb internal electronic components. Contact our Sales Department regarding our heavy duty “Slammer” Waveguide Connector.

Proper spacing between the two Waveguides is necessary to obtain accurate moisture measurements.

Using Long Waveguides

When longer Waveguides, such as 45 cm and 60 cm long, are mounted in the Waveguide Connector, the ends of the Waveguides can be flexed considerably during the insertion process. When using long Waveguides, it is important to guide the ends of the Waveguides when they enter the soil. Our accessory Model No. 6012, Alignment Block, should be used for this purpose.

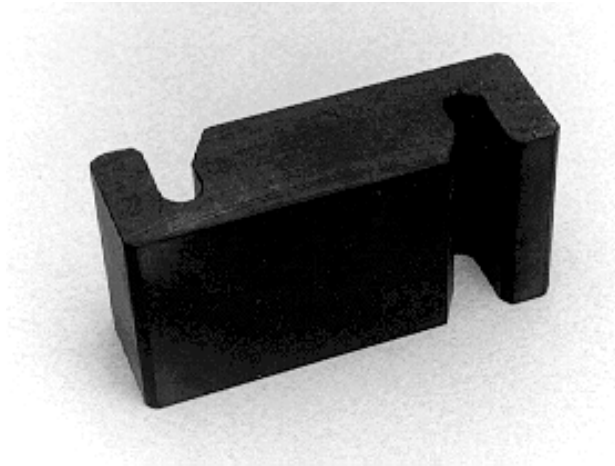

The ends of the Waveguides are inserted into the Alignment Block as they start to enter the soil.



This procedure starts the Waveguide entry into the soil with exactly the same spacing as in the Waveguide Connector and helps assure that they will be paralleled as they move down into the soil.

When the Waveguides are well into the soil, the Alignment Block can be twisted to free it from the Waveguides and removed.

Insertion In Dense Soils

Soils of high plasticity, compacted soils, very dry soils, and cemented soils require the use of our Model No. 6010, Installation Tool.

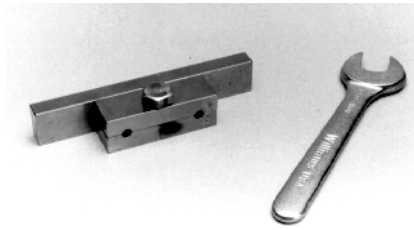

The Installation Tool is made from steel and plated for corrosion resistance. A wrench is provided with the Installation Tool. The Waveguides are mounted in the installation tool by first loosening the hex head bolt, slipping the grooved end of the Waveguides all the way down to the bottom of the holes, and then tightening the bolt securely.

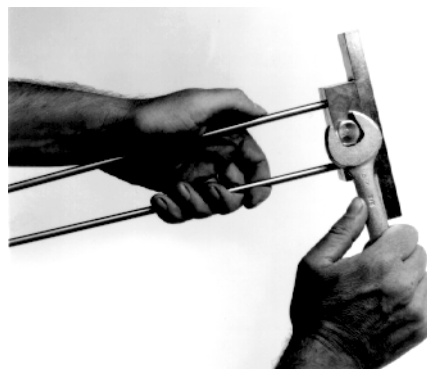

Use the Alignment Block to space the Waveguides, as shown. Drive the Waveguides into the soil. A mallet or similar heavy tool can be used.



When the Waveguides are mostly driven into the soil, remove the Alignment Block.

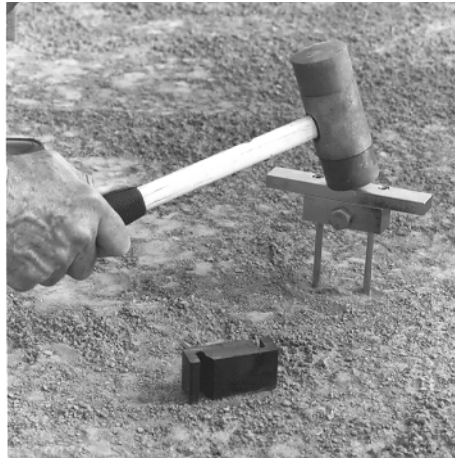

Drive the Waveguides all the way into the soil until the bottom of the Installation Tool is in contact with the soil surface.



Disconnect the Installation Tool by loosening the hex bolt with the wrench and lifting the tool off the Waveguides. The ends of the Waveguides will project slightly above the soil surface.

WAVEGUIDES

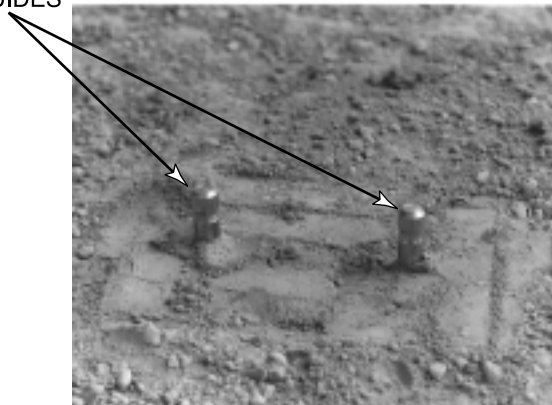

Align the Waveguide Connector over the ends of the Waveguides, as shown, and press down until the Waveguides are fully seated in the Waveguide Sockets of the connector. Then tighten the clamping knob on the Waveguide connector to secure contact with the Waveguides. The moisture reading can now be made.

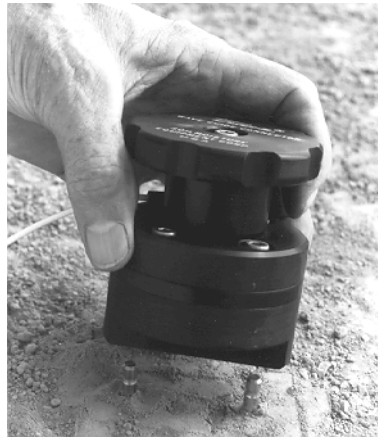

To remove the Waveguides, loosen the Clamping Knob on the Waveguide Connector and remove. Fit the protruding ends of the Waveguides into the holes of the Installation Tool. Make sure the Waveguides seat on the bottom of the holes in the Installation Tool. Tighten the hex bolt securely with the wrench. Use the Installation Tool to pull or pry the Waveguides out of the soil, as shown.



Repeat Readings At The Same Location

After installing Waveguides in the soil, as described above, they can be left in the field and tagged for identification and returned to for subsequent readings. The Waveguides are made of stainless steel and can be left in the field indefinitely.

Insertion In Containers

In order to obtain accurate results when making measurements in containers or pots, caution must be exercised regarding the size of the container. The Waveguide spacing (5 cm) is such that a volume of soil approximately the shape of a cylinder with radius of 4 cm is sampled.

Caution

Inserting the Waveguides too close to the wall of the container will introduce error in the moisture measurement. Measuring too close to the wall of the container will average, not only the soil, but, the dielectric of the container and the air outside the container. It is recommended that the Waveguides be inserted at least 2-3 cm (approx. 1 inch) from the wall of the container.

12-B. FIELD MEASUREMENTS USING BURIALABLE WAVEGUIDES

Installing Buriable Waveguides

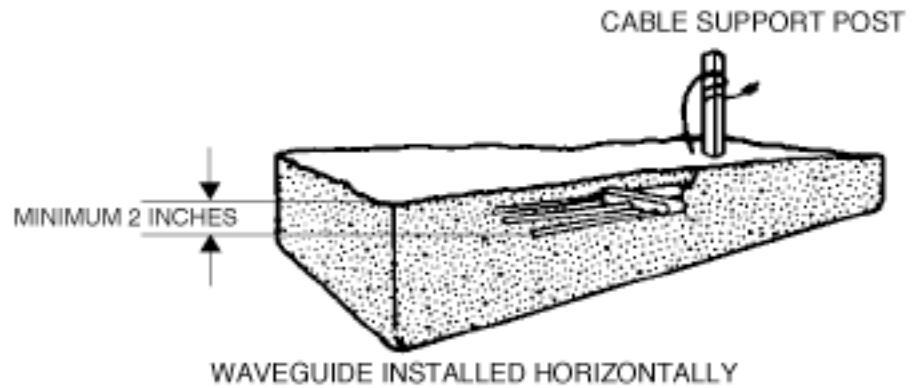

The Buriable Waveguide can be installed near the surface.

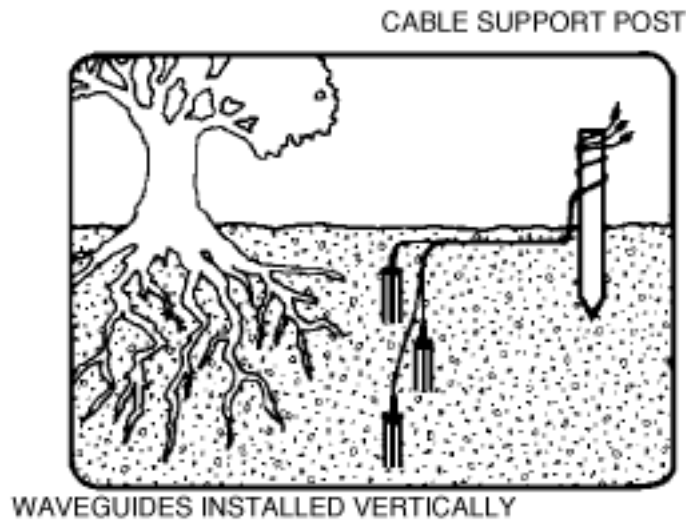

A group of Buriable Waveguides can be installed at various depths to monitor moisture in the soil horizon to program irrigation frequency and amount.

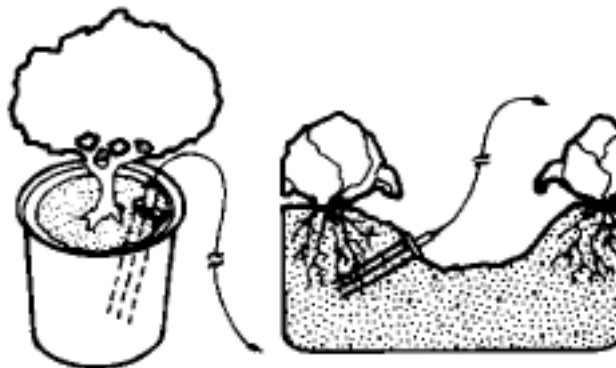

In light soils, and in many containers used in the nursery business and in research work, the Buriable Waveguide can be inserted from the surface by hand to its full depth for rapid evaluation of the moisture content.

Precautions When Installing Buriable Waveguides

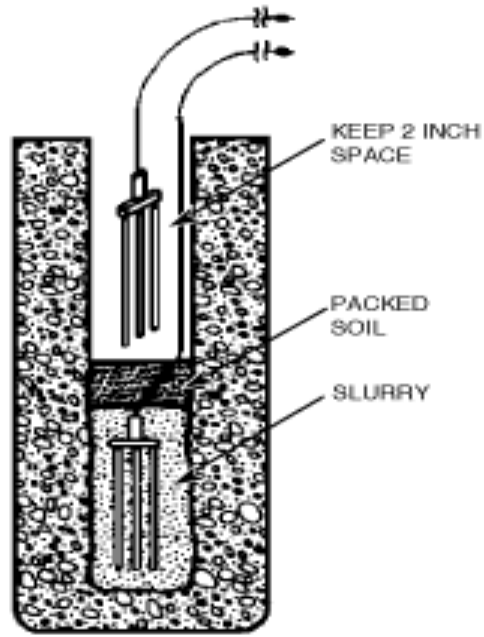

To secure an accurate moisture measurement it is essential that the metal rods of the Buriable Waveguide be in tight, intimate contact with the soil. This means that rods be inserted directly into the soil to retain bulk density characteristics or tightly packed around with native soil taken from the hole. In deep installations, a heavy slurry of water and native soil may be poured down the hole after inserting the Buriable Waveguide. Sufficient slurry should be used to completely cover the Buriable Waveguide. This should be followed by a small amount of soil which is then tamped in place with a small diameter rod.

Caution

When packing around the Buriable Waveguide, never use silica flour or other materials that differ in dielectric or volumetric character from the native soil in your location, since this can result in readings that are not representative of your soil.

When installing one Buriable Waveguide above another, make sure that the coaxial cable from the lower unit is kept at least 2 inches away from the metal rods of the upper unit.

When installing Buriable Waveguides horizontally near the surface, such as in seed beds, make sure that the metal rods are at least 2 inches below the surface in order to obtain accurate volumetric moisture content readings.

12-C. SEALING CONNECTING CABLES

When autologging and it is necessary to leave Trase out in the field, it is desirable to bring the coaxial cable from the Waveguide and perhaps a power cable through the hole in the side of the Storage Cover so that the cover can be closed to protect the Trase unit.

Accessory Cable Grommets are available for this purpose. The solid Cable Grommet in the Storage Cover is first removed by pushing from the inside as pictured and described under the section “Storage Cover and Contents” in Section 3, “Acquaint Yourself With The Parts”. The Waveguide Mount is also removed, as described in the same section. The accessory Cable Grommets with lead-thru holes can then be fitted into the Storage Cover. The photo below shows how the coaxial cable of the Waveguide Connector is mounted through the slot in the accessory Cable Grommet.



The BNC connector can then be fed through the hole in the Storage Cover and the grommet pushed into place, to seal the hole and the coaxial cable, as pictured below.



The BNC connector is then fed through the rectangular hole in the Cover Lid and connected to the BNC Port on the Control Panel. The Storage Cover can now be latched closed to seal the Trase unit while connection is maintained to the Waveguide Connector in the field.

In similar fashion, an accessory Cable Grommet with two holes can be used to seal the coaxial cable from the Waveguide Connector, as well as the power cable from the Battery Charger or other power source to provide long term operation.

The photo below shows how the two cables are mounted through the slots in the accessory Cable Grommet.

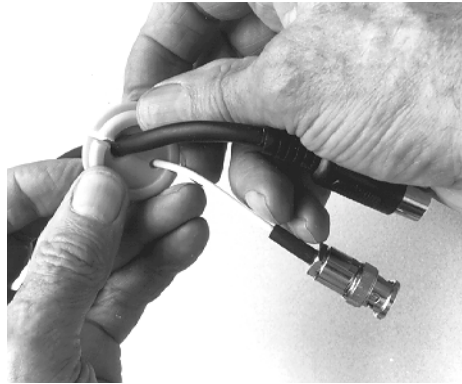

The photo below shows the accessory Cable Grommet with the two cables in place, with the Storage Cover closed to seal the Trase unit.



Note

When your work involves the use of long coaxial cables, refer to the section “Use of Long Coaxial Cables” in Section 13, “Technical Interface Information”. Cable lengths up to 40 meters are available on special request.

13. CUSTOM LOOKUP (MOISTURE) TABLES

Standard Moisture Table

The Trase software incorporates 4 Standard Moisture Tables (CUN, CCT, BUN, and BCT) which are used to convert the measured apparent dielectric constant, K_a , to volumetric moisture content, as explained in Section 2, “Principles and Techniques of Operation”.

The Standard Moisture Tables are located in a fixed place in memory and cannot be modified. The tables can be transferred, however, to an external terminal for review.

Custom Moisture Tables

When moisture measurements are required in materials or unusual soils, where the relationship of K_a to percent of moisture is radically different from conventional soils, a Custom Moisture Table can be prepared and entered into the Trase software. The Trase system provides a separate place in memory to store 4 Custom Moisture Tables (T01, T02, T03, and T04) which are separate from the Standard Moisture Tables.

To make up a Custom Moisture Table it is necessary to prepare a series of samples of the material with known volumetric moisture contents to span the range of moisture content that is of interest. The samples must be of sufficient volume so that the dielectric constant, K_a , of the samples can be measured using Trase with standard waveguides inserted into the samples.

The development of the table relating the known volumetric moisture content to the dielectric constant, K_a , at a series of increasing moisture contents must be done carefully to maintain measurement accuracy in the field.

A Custom Moisture Table needs to consist of a series of volumetric moisture content values and the corresponding K_a values.

To Enter A Custom Moisture Table By Hand

To enter a Custom Moisture Table you must first have a terminal, or a computer used as a terminal, connected to the RS-232 Serial Port on the Trase unit with the baud rate set to match the Trase setup [the default is 9600]. See “Setting the Data Transfer Parameters” in this section for further details.

Steps:

1. Key to the Setup Screen.

2. Press the  key.

3. The following prompt will appear on the terminal:

“ Type each table entry as K_a , moisture. Press  after each

entry. Example: 15.3,.351<ENTER>. Press  again after last entry. Begin!”

1 = T01

2 = T02

3 = T03

4. Type in the entries. After the last entry, press the **ON ENTER** key again.
5. The following prompt will appear on the terminal:
 “XX entries.
 Enter the table destination.
 1 = T01
 2 = T02
 3 = T03
 4 = T04
 Selection (default = 1): (You will enter either 1,2,3, or 4 to select the destination for your new custom table).
6. After you have entered the table number, you will be prompted as follows:
 “Enter table label (8 characters alphanumeric maximum): (You will now enter the name for your custom table).
7. The following message will confirm that your custom table has been entered:
 “New table values stored in table TXX (the x’s designating the table number selected).

To Enter a Custom Moisture Table From a File

- Steps:
1. Prepare the file. The file should contain one entry per line. Each entry is the Ka value, a comma, then the moisture value. The moisture value is expressed as a three place decimal. For example, 5.0% is written .050, and 27.5% is written as .275. Ka is carried to a one place decimal. The following example of the first four lines of our standard table are: (see GRAPH 2.1 & 2.2)
- 2.0, 0.000
 3.8, 0.050
 6.0, 0.100
 7.8, 0.150
2. As with entering a custom moisture table by hand, you must have a terminal, or a computer used as a terminal, connected to the RS-232 Port of the Trase unit with the baud rate set to match the Trase setup - the default is 9600. See “Setting the Data Transfer Parameters” in this section for further details.
 3. Key to the Setup Screen.
 4. Press the **SAVE READING** key.
 5. The following message will appear on the terminal:
 “ Type each table entry as Ka, moisture. Press **ON ENTER** after each entry.
 Example: 15.3,.351<ENTER>. Press **ON ENTER** again after last entry. Begin!”
 6. Using the ASCII upload feature of your communication program, send the file to Trase.
 7. After the file has been uploaded to your Trase unit the following message will appear on your terminal:
 “XX entries.
 Enter the table destination.
 1 = T01

2 = T02

3 = T03

4 = T04

Selection (default = 1): (You will enter either 1,2,3, or 4 to select the destination for your new custom table).

8. After you have entered the table number, you will be prompted as follows:
“Enter table label (8 characters alphanumeric maximum): (You will now enter the name for your custom table).
9. The following message will appear on the terminal confirming your custom table has been entered:
“New table values stored in table TO# (the #'s designating the table number selected).

Note

If you have problems transferring data, you may have to set your communication program upload to “line at a time”. The communication program will not send the next line until it has received the echo from the previous line.

Transfer A Moisture Table From Trase

To transfer a Moisture Table you must have a terminal or a computer, used as a terminal, connected to the RS-232 Serial Port with the baud rate set to match the Trase setup - the default is 9600. See “Setting the Data Transfer Parameters” in this section for further details.

Steps:

1. Key to the Setup Screen.
2. Select either one of the 4 Standard or one of the 4 Custom Tables in the “Moisture Table” field.
3. Press the  key.
4. The table will be displayed on the screen in the same format as used in entering a moisture table.

Note

When the Trase software calculates the moisture content it considers that there is a linear relationship of Ka to moisture content between two adjacent Ka values in the table.

If the Custom Moisture Table you are entering only covers a part of the full range of moisture, for example 0-40%, where, say, 40% corresponds to a Ka value of 26.0, then, if in the course of making measurements a Ka value of greater than 26.0 is encountered, Trase will always report 40% moisture. If you want to know that a measurement exceeds the range of your moisture table, you can assign a Ka value of, for example, 26.5 just slightly above 26.0, and relate this to 99.9% moisture. Then when making a reading, if Trase reports 99.9% moisture, you will know that the moisture value measured is beyond the range of your Custom Moisture Table.

14. TECHNICAL INTERFACE INFORMATION

Power Port Pin Assignment For Auxiliary Power

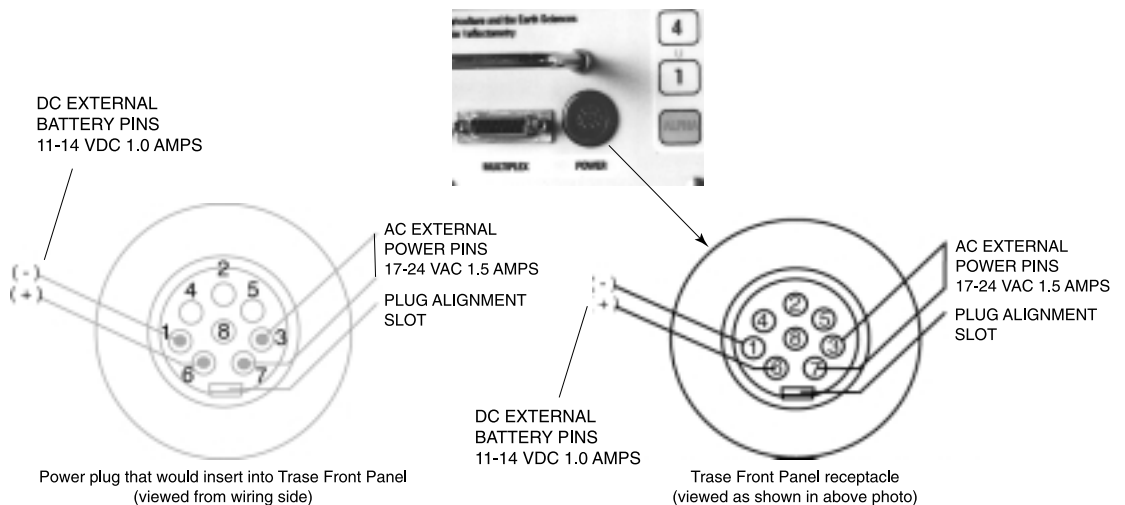

The above figure shows the pin connections for auxiliary power. Normally the TDR Processor is powered either by its internal battery or the Battery Charger supplied with it.

There may be, however, occasions when you want to power the Trase in the field from a local power source. You can connect AC or DC power to the External Power Pins or you can connect a 12 volt battery to the External Battery Pins. An accessory 8 pin DIN connector is required. The following table specifies the requirements for these inputs.

	Input	AMPS (Current)	Battery
Power Supply Pins	17-24 VAC	1.5	Charges battery
External Battery Pins	11-14 VDC	1.0	Connect as auxiliary DC battery supply

The External Power Supply input will fully charge the internal batteries.

Note

Pins 7 & 3 provide for AC low power input from conventional wall or desk “down converters”, from standard office line voltages of 110 VAC/220 VAC. These same input pins are used in connecting the Trase chargers supplied with your unit. An internal power circuit takes this AC input converting it to a DC current that charges Trase’s battery pack. Pins 1 & 6 can be used to connect additional batteries in parallel to those internal to Trase. Such external batteries can provide additional power resources for very heavy duty applications. This is also recommended if you are operating Trase on external power over an extended period.

Multiplex Port Pin Assignments

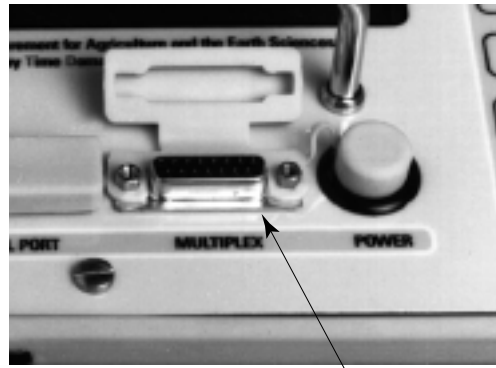

MULTIPLEX PORT

Sequence Switch

The Multiplex Port provides access to the Sequence Switch which is activated momentarily immediately after each reading is made when in the Autolog Mode. The Sequence Switch is turned on with the active time interval selected in the Autolog Screen as covered in Section 10, "Using the Autolog Screen".

The Sequence Switch is a Double Throw Single Pole switch which can be incorporated into one leg of an external circuit to control or sequence other devices.

Sequence Switch specifications:

Voltage: 30VDC or VAC, maximum
Switching Current: 2 Amp, AC or DC

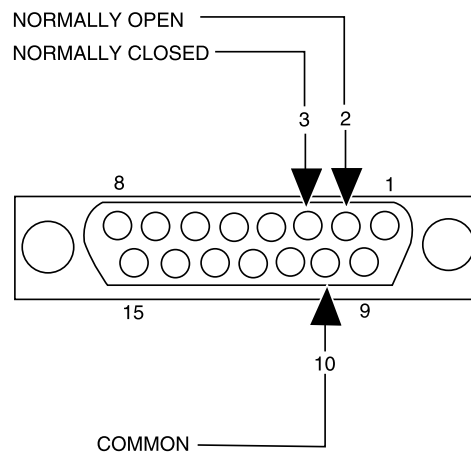

When the Sequence Switch is activated, pins #2 and #10 are connected. When the switch is not activated, pins #3 and #10 are connected.

RS-232 Serial Port Pin Assignments

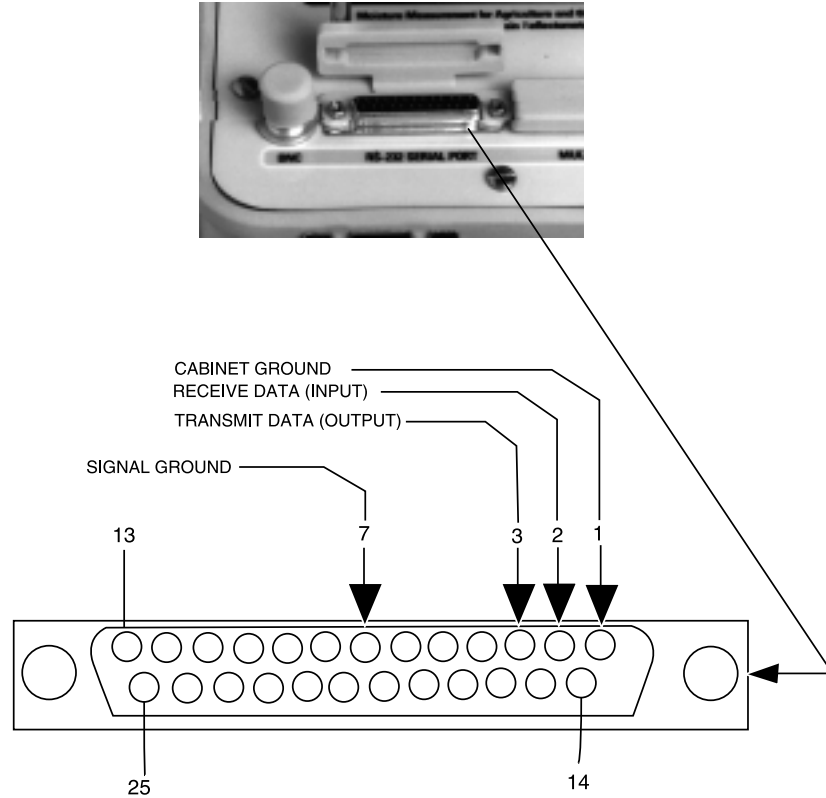

The above figure shows the pin connections for the RS-232 Serial Port.

RS-232 Serial Port Specifications:

Device:	DTE
Baud rates:	300, 1200, 2400, 4800, 9600, 19.2 K, 38.4 K
Data bits:	7
Parity:	zero, even, odd
Stop bits:	1 or 2
Hardware handshake:	none
Flow control:	Xon/Xoff or none

The Soilmoisture default settings for the RS-232 communications port are as follows:





Baud Rate	9600
Stop Bit	1
Parity	none
Flow Control	Xon/Xoff
Sending Format	printer

Setting Trase Communications Parameters

Before transferring data, determine the auxiliary equipment data transfer parameters and set these parameters on the Trase Setup Screen.

Key to the Setup Screen as described under Section 6, “Using the Setup Screen”.

```
          SETUP SCREEN
Copyright 1988-95 SEC          6058C6-2000
Length units: millimeters <->
Cable loss: 0.0 dB/100 ft
Moisture table: CUN <-> Label: Con Unco
Date: (dd-MMM-yy)
Time: (hh:mm:ss)
Capture Window: 10 nS <->
Storage: 1 <-> Label:
Baud Rate: 9600 <->
Stop bits: 1 <-> Modem: None <->
Parity: none <->
Flow control: xon/xoff <->
              commas <->
              240 secs <->
16-JAN-95 0:52:53
```



Then press  key or  key to bring the cursor into the “Baud” selection field. Baud rates of 300, 1200, 2400, 4800, 9600, 19.2 K, and 38.4 K are displayed. To select the number you require, press the  key or the  key.



To set up the “Stop bits”, press the  key to scroll the cursor to this field.



Then press the  key or  key to select to either 1 or 2, whichever is required.

Modem: Move to the “Modem” field by pressing  and select either “none” to transfer directly by cable or “yes” to transfer data by telephone.

WinTrase software is required for modem operation of Trase. If you do not have WinTrase software, leave the “modem” field set at “none”. You may contact our Sales dept. if you are interested in remotely accessing your Trase unit by telephone modem.

To set the “Parity”, press the  key to move the cursor to this field. This field scrolls through parity of “none”, “even” or “odd”. To scroll to the parity you require, press the  key or the  key.

To set the “Flow control”, press the  key to move the cursor to this field: choices displayed are “none” and “xon/xoff”. Select your choice by pressing the  key or the  key to scroll to the desired choice.

To set the “Sending format”, press the  key to move the cursor to this field. Sending format of “1-2-3”, “commas”, or “printer” are displayed. To scroll to the format you require, press the  key or the  key. When sending both readings and graphs, you must select “commas”.

Trase is now programmed to transfer the data in the mode required by the auxiliary equipment.

RS-232 SERIAL PORT CABLING FOR COMMUNICATIONS

Cabling For PC/Trase Communication

You can send reading and graph information from the Trase TDR Processor to a personal computer. This information can be stored in files and then used with spreadsheet, plotting or other programs. All data, including graphs sent by Trase, are ASCII characters. In other words, the data is sent as ordinary text.

Your personal computer must have an RS-232 serial port. In addition, you must have a communication program. The following steps show how to send the readings in printer format to a file in the PC. You can repeat this process with other SENDING formats. Before trying the following example, save several readings so you will have data to send.

Connect an RS-232 cable between the RS-232 Serial Port on the Trase Processor and a serial port on your personal computer. The figure below shows the schematic diagram for this cable. The connector at the Trase end is an industry standard male DB-25. The connector at the personal computer end is usually DB-25, but may be male or female; check your computer’s manual. The figure below shows the minimum connections required.

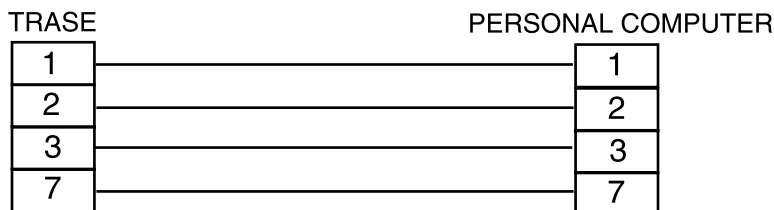

You can also use a cable with all pins connected.

**Trase Default
Communications
Setting**

The Soilmoisture default settings for the RS-232 communications port are as follows:

Baud Rate	:	9600
Stop Bit	:	1
Parity	:	none
Flow Control	:	Xon/Xoff
Sending Format	:	printer

The Trase System must be set to match the RS-232 communications port of the receiving system.

Note

If changes in the settings are necessary, select to the Setup Screen and make necessary changes in values by moving the cursor to the appropriate field and selecting the appropriate matching values, as described earlier in this section under "Setting the Data Transfer Parameters".

Know your "COM" ports. There can be more than one serial com port on a PC. It is essential that your communication program and Trase be connected to the same port. All our examples will use COM1 for long distance remote control of Trase using a modem and WinTrase software. Adjust your "COM" port number on your PC to match the serial "COM" for your modem, assure WinTrase is also set for same com port.

The following examples are the procedures for sending data to a PC using two popular communication software packages. The first one runs under DOS and is called, "PROCOMM" - version REV 2.4.3 (Datastorm Technologies Inc.). The second is called "TERMINAL" - version 3.1 (Microsoft) and is an application program included with Windows. There are many other communications programs that will also work.

Connecting To PC's

DIRECT TRASE/PC CABLING

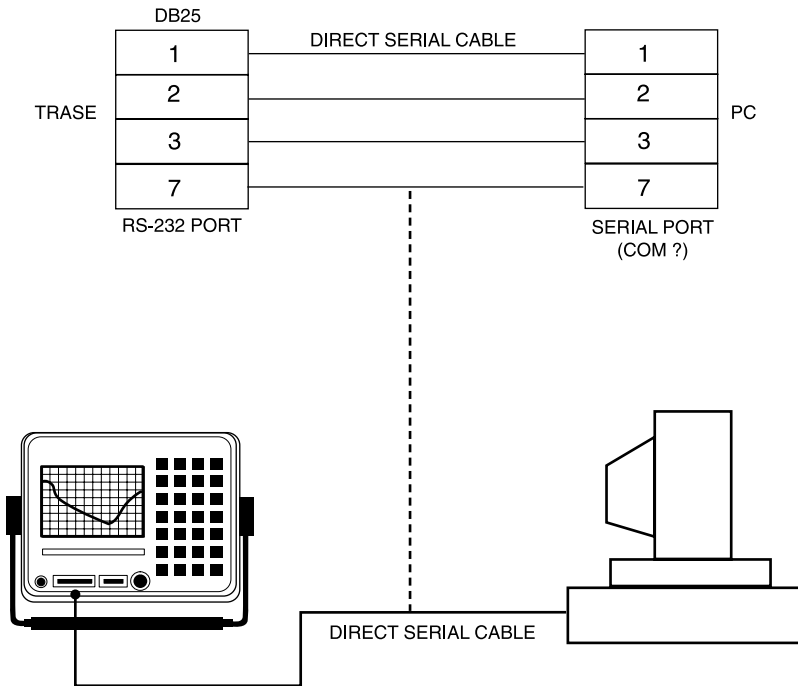

This connection allows users to conveniently download readings, graphs and tables from Trase or remotely at the PC with WinTrase.

DIRECT CONNECTION TO SERIAL PRINTER

DIRECT TRASE TO SERIAL PRINTER USING NULL MODEM CABLE OR DIRECT SERIAL CABLE OR WITH NULL CONNECTOR

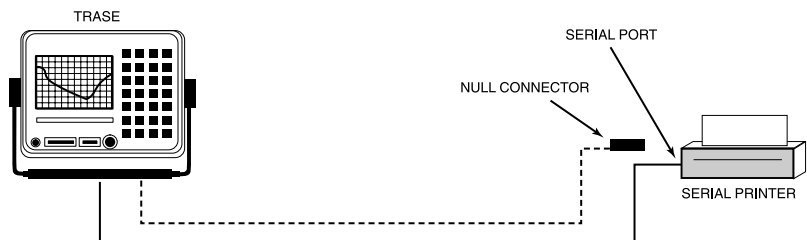
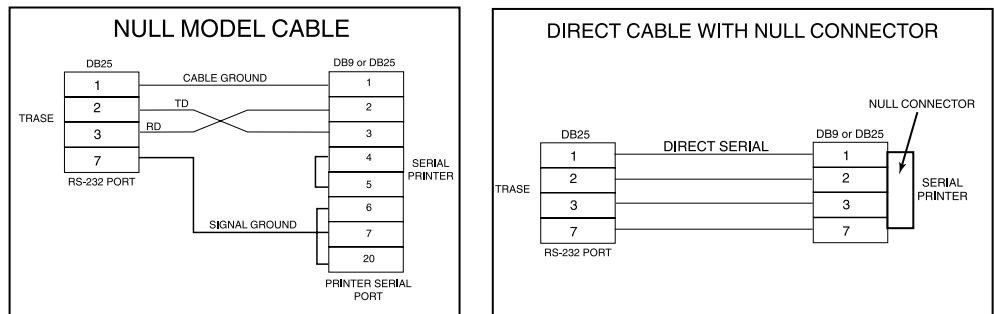

You can connect a printer to the TDR Processor and get a printout of the stored readings. The printer must have an RS-232 Serial Port interface, sometimes called a “serial” interface. The following figures show the schematic diagrams for suggested connections.

This connection is for use with older style serial printers where no computer is available. This kind of arrangement provides direct printer output from Trase to a printer.

CONNECTING TRASE SERIAL PORT TO A PARALLEL PRINTER

Direct Trase to parallel printer using serial/parallel printer

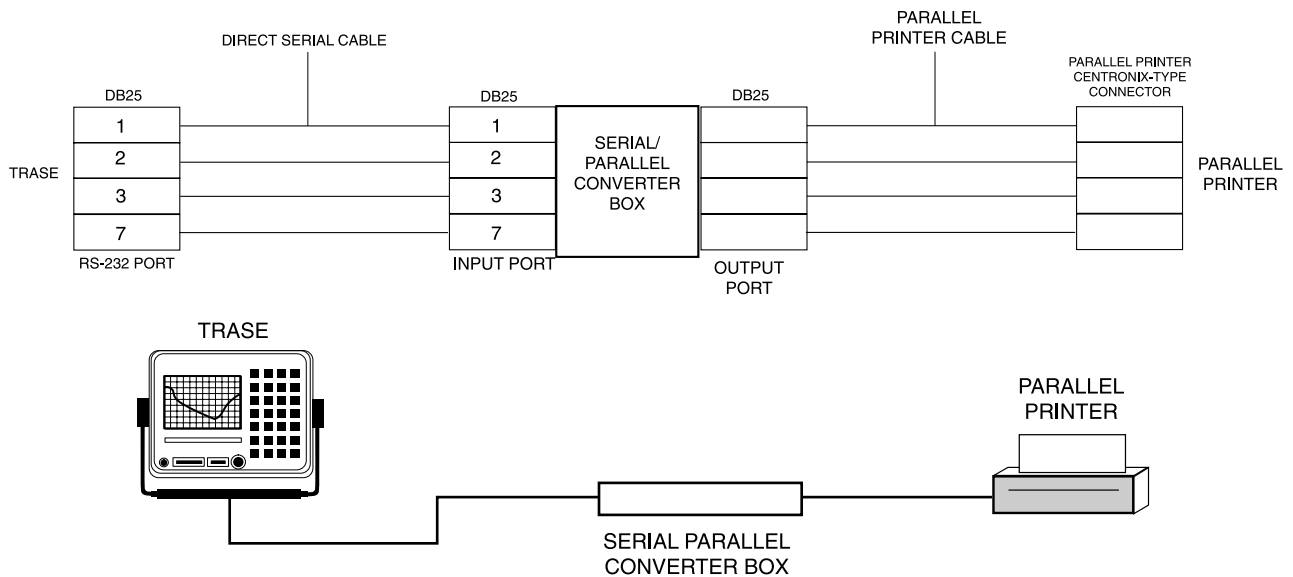

Use of serial/parallel conversion equipment allows Trase to output directly to printers with Centronix type connections. This is seldom done, it being more preferable to use a PC computer connected directly to today’s standard parallel laser printers.

CONNECTING TRASE TO A REMOTE SITE VIA MODEM

CONNECTING TRASE TO A REMOTE SITE VIA MODEM

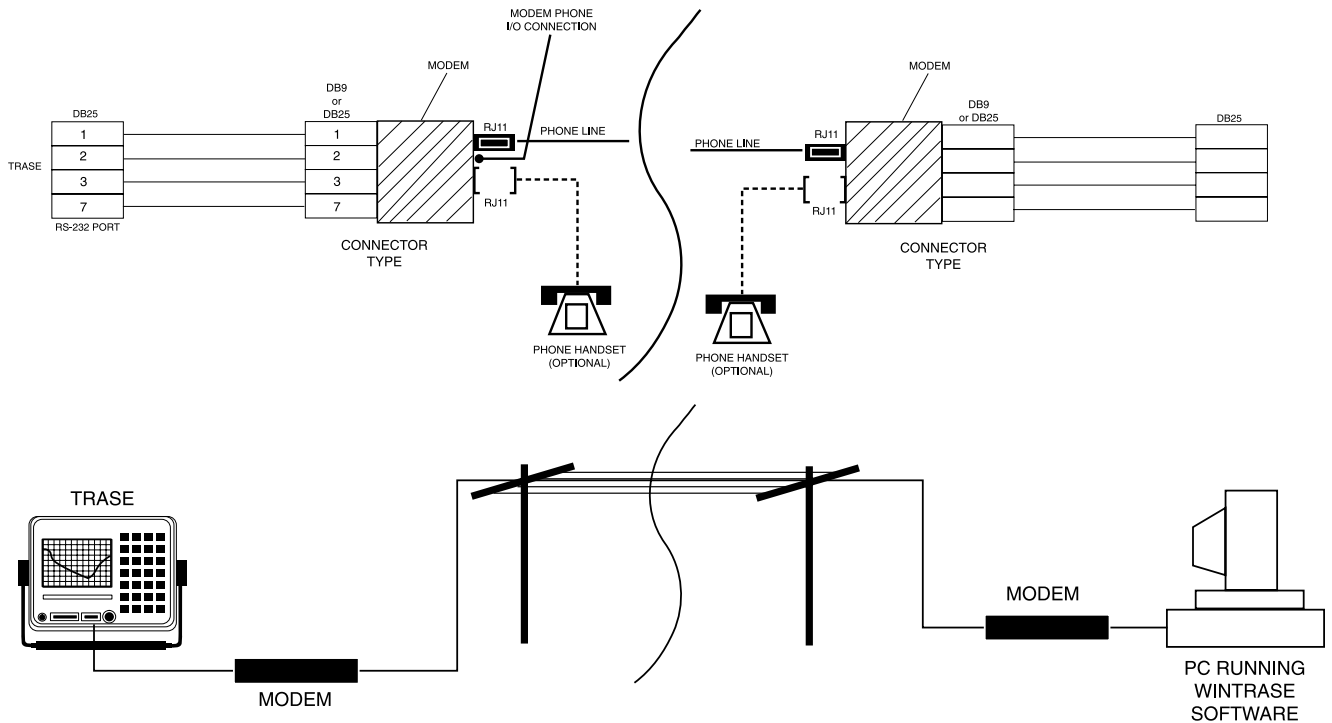

The example shown above illustrates the ability of Trase System I or Trase BE to be controlled from a remote location using WinTrase Windows software on a computer with modem access and Trase connected to a phone line using a modem. This new feature of the Trase instrument provides a method of accessing and measuring sites several miles to several thousand miles away. If you're interested in this method of modern access and remote control for your Trase, contact our sales department for further details.

15. COMMUNICATIONS FOR SENDING/RECEIVING DATA

There are ways to set basic fundamental operating conditions of your computer using “Mode” and “Comm” and other settings with batch commands to communicate with Trase directly, but these take a technical understanding of your particular PC and it’s equipment. It is far easier and much more convenient to use a standard “communications packages”. The following examples are application programs for sending data to/from the PC to Trase using easily accessible shareware or system communications packages. The first is a good basic communications package that operates under DOS (non-windows) offered by Datastorm Technologies Inc. in a shareware evaluation package. The second is called “Terminal” ver. 3.1, and comes as standard utility in Windows 3.1. There are of course many more communications packages to suit your specific needs.

Finding ProComm 2.4.3

Procomm 2.4.3 is a limited use shareware program by Datastorm Technologies, Inc. that can be downloaded from their bulletin board service (BBS). To download, 1) dial (573) 875-0503. You will be prompted for user name and a password. For a password, enter your own creation of 5-8 characters. 2) From the main menu select F for File Transfer. 3) Select D for Download, 4) Download the file PROCOMM.EXE 5) For more data on it’s use, print file at dos C:\Procomm\PROCOMM.DOC. For registration and technical support on this program call Datastorm Technologies, Inc. at (314) 443-3282. It is also available from Soilmoisture on our World Wide Web site at URL: <http://www.soilmoisture.com> as procomm.exe, under our tools icon as part No. 8010. Newer more advanced versions of this and other communications are available from Datastorm Technologies, Inc. either directly as “Procomm for Dos” or from a local PC software retailer.

How To Set Up ProComm 2.43 On a PC (For Direct Port Transfer)



1. Call up the ProComm program on the computer. The screen will have a status bar at the bottom of the screen.
2. Press the [ALT] and the [P] key on the computer. The Line Setting window will come up on the screen.
3. Enter [11] to select 9600, n, 8, 1. Then enter [22] to select COM1. The Current Setting Line should read: 9600, n, 8, 1, COM1. (**Remember to select the actual COM# port that the serial cable or modem is attached to, in many cases it will NOT BE COM1**).
4. To save this configuration, enter [24]. This configuration is saved on the computer and will be used from now on as the computer default setting. This configuration portion of the ProComm program will not have to be used again.

How to Set Up Trase

The computer is now configured to the same settings as the default settings on the Trase system and is ready for data transfer. For this example, the file name “Trasedat.txt”, will be used.

5. Press [PgDn] key on the computer to open the Download window.
6. Press the [7] key to select ASCII. When the [Enter] key is pressed, the system will respond with the Receive In window. Enter the filename “Trasedat.txt”. The PC system is now ready to receive a data file from the Trase System.

How To Exit ProComm

Key to the Data Screen, key the cursor into the “Storage” selection field. Press the  key or  key until you scroll to the storage area from which you wish to transfer data. Then press the  key. Cursor will flash as data is sent.

How To Set Up Windows Terminal Program on a PC

When the data transfer is complete, exit the ProComm communications program as follows:

1. Press the [ESC] key on the computer to exit the transfer window.
2. Press the [Alt] key and [X] key on the computer to call up the Exit window.
3. Press the [Y] key and then [Enter]. The system will respond by exiting the ProComm program.

The Terminal program is normally found in the “Accessory Group” applications provided in the standard load of Microsoft Windows 3.1. operating system.

The parameters for the RS-232 communications port used in the ProComm program will be the same as used in this example for Windows. All the steps for the Trase System setup and data transfer are also the same.

1. Open the Terminal Icon.
2. Open Settings menu under the Terminal Window.
3. Open the Communications window. Under the Connector heading, select the COM port to which the serial cable or modem is connected. In our example we use COM1, yours may differ. Select baud rate at 9600, No parity, 1 stop bit, and 8 data bits. We also recommend you choose the Xon/Xoff flow control.
4. Select [OK] to save this configuration.
5. Open the File Menu under the Terminal Window. This will open the “File Save As” window.
6. Enter the file name “TRASE.TRM”. This will save the current RS-232 communications port setting to be used by Windows and can be called up from the File Menu under the Terminal Window automatically configuring the computer.
7. Open the Transfer Menu under the Terminal Window.
8. Select “Receive Text File...”. The system will open the Receive Text File Window.
9. Enter the file name “TRASEDAT.TXT” and select [OK]. The system will respond with “Receiving: TRASEDAT.TXT” at the bottom of the

Receive Text Window. Start the data transfer from the Trase System by keying to the Data Screen and pressing the [SEND DATA] key.

10. Select [STOP]. The system will close the Receive Text File Window.
11. Close the Terminal Window. The system will return to the Terminal Icon.

Sending Individual Data

To send only the individual data of a measurement (i.e. no graph information) from the Data Screen, select the individual data desired by scrolling to it and then press the  key. The connections between Trase and the printer or computer and the Sending Format are the same as described under “Sending Readings to a Printer” and “Sending Data to a Personal Computer” in this section.

Sending Individual Graphs

The series of x-y coordinates defining an individual graph can be sent to a printer or computer from the Graph Screen.



The connections between Trase and the printer or computer are the same as described under “Sending Readings to a Printer” and “Sending Data to a Personal Computer” in this section. When sending graphs, you should also be sure to select the sending format as “commas” mode or “1,2,3” mode. This selection is done in the Setup Screen as described under “Setting the Data Transfer Parameters” in this Section.

After connections are complete, key to the Graph Screen, display the graph desired, and press the  key. When Trase sends a graph, it sends 1,200 lines. The current date and graph coordinates will be immediately transferred. During the transfer process, the message “SENDING SINGLE GRAPH...” will be displayed in the center of the screen. When data has been transferred, select “STOP” on the terminal.

The upload of data will consist of the reading followed by the graph data. If the reading used one of the user-defined custom tables, the table will follow the graph data.

Sending All Graphs In One Storage Area

All graphs in one storage area can be sent at one time to a printer or computer from the Data Screen. The connections between Trase and the printer or computer and the Sending Format are the same as for sending individual graphs as described above.

After connections are complete, key to the Data Screen, select the Storage Area desired by scrolling to it with the cursor. Then press the  key and then the  key. “SHIFT” will remain on the Trase screen until all data has been sent. When data transfer has been completed, select “STOP” on the terminal.

THE THREE SENDING FORMATS

Readings can be sent in one of three different formats : "printers", "commas" and "1-2-3". These formats can be selected by going to the SETUP SCREEN.

Use the  key to move the cursor to the "SENDing format" field. Next

use the  key or the  key to select the format you wish to send. Following are the different format examples.

Readings Output in Printer Format ASCII File

Readings sent as printer format

```
Storage Area 1 PRNG 25-OCT-95 15:49:37 Page 1
```

No.	Tag	Waveguide MUX			Zero			Date	Time	P	Error
		%M	Ka	cm	Typ	Ch	G Tab T ns				
1	SAND	3.5	3.3	20.0	CON	0 0	BUN	12.7	25-OCT-95	8:36:52	1
2	SAND	3.4	3.3	20.0	BUR	0 0	BUN	12.9	25-OCT-95	8:37:57	1
3	SOIL	14.9	7.8	20.0	BUR	0 0	BUN	13.0	25-OCT-95	8:39:57	1
4	CLAY	35.0	21.2	20.0	BUR	0 0	BUN	13.1	25-OCT-95	8:53:36	N
5	SOIL	5.4	4.0	19.0	CON	0 0	CUN	13.6	25-OCT-95	8:58:10	1
6	SOIL	22.8	11.6	19.0	CON	0 0	CUN	13.6	25-OCT-95	8:59:06	1
7	CLAY	22.2	11.2	19.0	CON	0 0	CUN	13.6	25-OCT-95	9:02:27	1
8	CLAY	37.2	23.3	19.0	CON	0 0	CUN	13.6	25-OCT-95	9:03:13	N
9	SOIL	16.7	8.6	20.0	BUR	1 0	BUN	89.3	25-OCT-95	9:26:04	1
10	SAND	4.2	3.5	20.0	BUR	16 0	BUN	89.1	25-OCT-95	9:44:17	1
11	CLAY	35.9	22.1	20.0	BUR	3 0	BUN	88.8	25-OCT-95	9:54:57	N
12	SOIL	3.1	3.1	20.0	BUR	0 0	BUN	14.6	25-OCT-95	11:00:29	1
13	SOIL	22.6	11.5	40.0	BUR	0 0	BUN	144.0	25-OCT-95	13:23:40	1

Readings Output in Printer Format EXCEL File

Readings sent as printer format seen in Excel

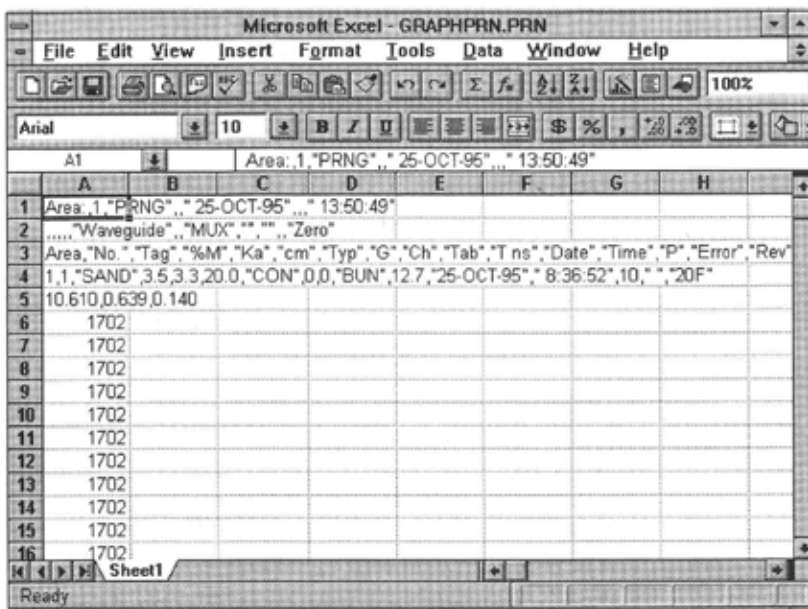

Area	No.	Tag	%M	Ka	cm	Typ	G	Ch	Tab	T ns	Date	Time	P	Error
1	1	SAND	3.5	3.3	20.0	CON	0	0	BUN	12.7	25-OCT-95	8:36:52	10	20F
6														
7														
8														
9														
10														
11														
12														
13														
14														
15														
16														

**Graph Output
in Printer
Format
ASCII File**

A graph sent in printer format

```
"Area:",1,"", " 02SEP2004",,,, " 09:13:17"
,,,,,"Waveguide",,"MUX",,"",,"Zero"
"Area","No.,"Tag","%M","Ka","cm","Typ","G","Ch","Tab","T ns","Date","Time","P","Message","Rev"
1,1,"SAND",4.2,3.5,20.0,"BUR",0,0,"BUN",11.4,"02SEP2004","08:33:04",10,"", "21E "
7.000,0.763,0.120,"MUX/OFF",0.000
1365
1365
1365
1365
1365
1365
1365
1365
1365
1365
1364
1364
1364
1364
1363
1363
1363
1363
1364
1364
1366
```

Graph, printer format as seen in Excel

**Graph Output
in Printer
Format
EXCEL File**

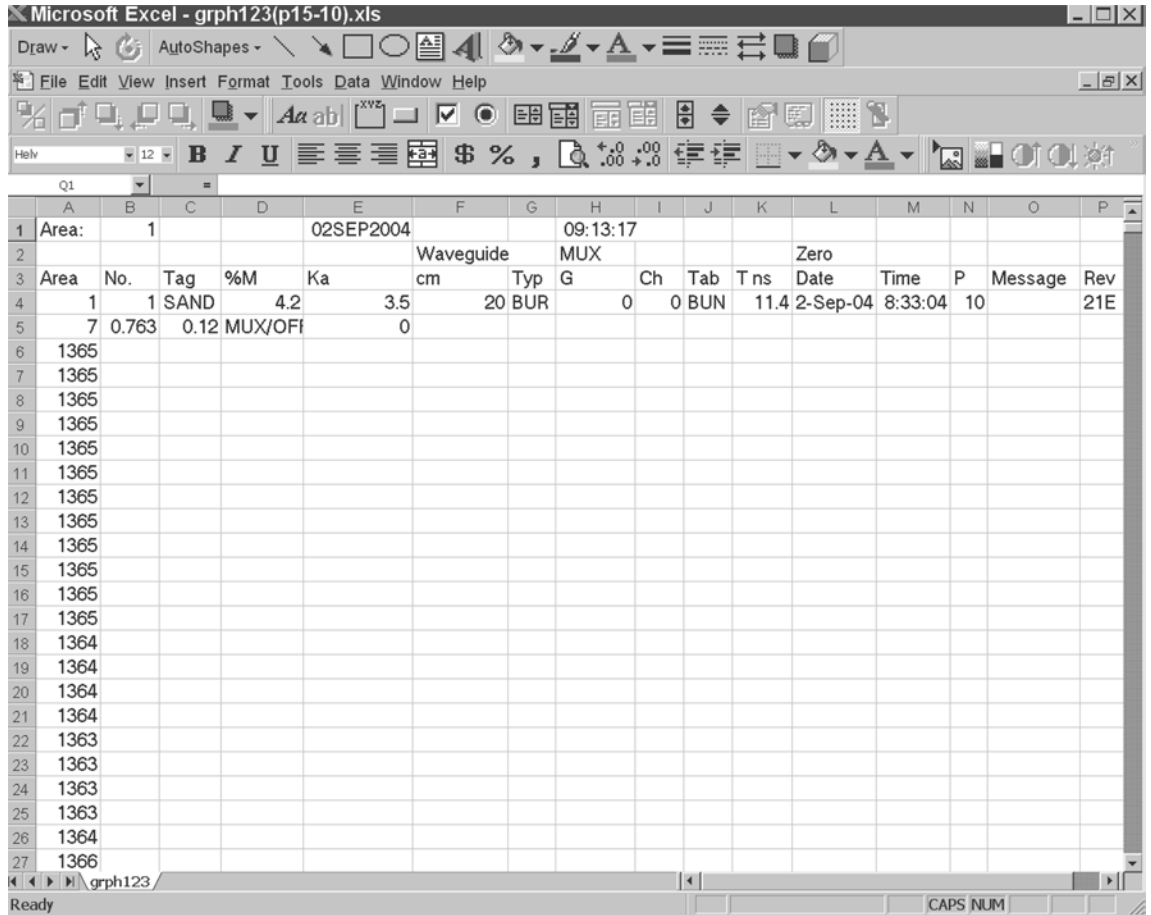

**Readings
output in
“CSV” format
ASCII file**

Readings sent in Comma format

```

1,1,"SAND",4.2,3.5,20.0,"BUR",0,0,"BUN",11.4,"02SEP2004","08:33:04",10," ", "21E "
1,2,"SOIL",4.2,3.5,20.0,"BUR",0,0,"BUN",11.3,"02SEP2004","08:34:06",10," ", "21E "
1,3,"SOIL",11.2,6.5,20.0,"BUR",0,0,"BUN",11.0,"02SEP2004","08:34:49",10," ", "21E "
1,4,"SOIL",6.4,4.4,19.0,"CON",0,0,"CUN",13.2,"02SEP2004","08:38:18",10," ", "21E "
1,5,"CLAY",22.8,11.6,19.0,"CON",0,0,"CUN",13.2,"02SEP2004","08:38:58",10," ", "21E "
1,6,"CLAY",38.8,25.1,19.0,"CON",0,0,"CUN",13.2,"02SEP2004","08:39:43",10," ", "21E "
1,7,"SILICA",26.8,14.5,60.0,"CON",0,0,"CUN",13.2,"02SEP2004","08:40:49",10," ", "21E "
1,8,"SILICA",5.3,3.9,60.0,"CON",0,0,"CUN",13.2,"02SEP2004","08:41:31",10," ", "21E "
1,9,"CLAY",34.7,21.0,20.0,"BUR",0,0,"BUN",11.3,"02SEP2004","08:42:32",10," ", "21E "
1,10,"SAND",4.5,3.6,20.0,"BUR",0,0,"BUN",74.1,"02SEP2004","08:44:06",10," ", "21E "
1,11,"SOIL",4.7,3.7,20.0,"BUR",0,0,"BUN",74.0,"02SEP2004","08:45:29",10," ", "21E "
1,12,"SOIL",12.7,7.0,20.0,"BUR",0,0,"BUN",73.7,"02SEP2004","08:46:26",10," ", "21E "
1,13,"CLAY",35.2,21.4,20.0,"BUR",0,0,"BUN",74.0,"02SEP2004","08:47:05",10," ", "21E "
1,14,"SOIL",6.1,4.3,19.0,"CON",0,0,"CUN",76.0,"02SEP2004","08:48:38",10," ", "21E "

```

**Readings
output in
“CSV” format
EXCEL file**

Readings, Comma format, as seen in Excel

	A	B	C	D	E	F	G	H	I	J	K	L	M	N	O	P
1	1	1	SAND	4.2	3.5	20	BUR	0	0	BUN	11	2-Sep-04	8:33:04	10		21E
2	1	2	SOIL	4.2	3.5	20	BUR	0	0	BUN	11	2-Sep-04	8:34:06	10		21E
3	1	3	SOIL	11.2	6.5	20	BUR	0	0	BUN	11	2-Sep-04	8:34:49	10		21E
4	1	4	SOIL	6.4	4.4	19	CON	0	0	CUN	13	2-Sep-04	8:38:18	10		21E
5	1	5	CLAY	22.8	12	19	CON	0	0	CUN	13	2-Sep-04	8:38:58	10		21E
6	1	6	CLAY	38.8	25	19	CON	0	0	CUN	13	2-Sep-04	8:39:43	10		21E
7	1	7	SILICA	26.8	15	60	CON	0	0	CUN	13	2-Sep-04	8:40:49	10		21E
8	1	8	SILICA	5.3	3.9	60	CON	0	0	CUN	13	2-Sep-04	8:41:31	10		21E
9	1	9	CLAY	34.7	21	20	BUR	0	0	BUN	11	2-Sep-04	8:42:32	10		21E
10	1	10	SAND	4.5	3.6	20	BUR	0	0	BUN	74	2-Sep-04	8:44:06	10		21E
11	1	11	SOIL	4.7	3.7	20	BUR	0	0	BUN	74	2-Sep-04	8:45:29	10		21E
12	1	12	SOIL	12.7	7	20	BUR	0	0	BUN	74	2-Sep-04	8:46:26	10		21E
13	1	13	CLAY	35.2	21	20	BUR	0	0	BUN	74	2-Sep-04	8:47:05	10		21E
14	1	14	SOIL	6.1	4.3	19	CON	0	0	CUN	76	2-Sep-04	8:48:38	10		21E
15																
16																
17																
18																
19																
20																
21																
22																
23																
24																

**Graph Output
in "CSV" format
ASCII file**

Graph, sent in Comma format

```

1,1,"SAND",4.2,3.5,20.0,"BUR",0,0,"BUN",11.4,"02SEP2004","08:33:04",10," ", "21E "
7,000,0.763,0.120,"MUX/OFF",0.000
1365
1365
1365
1365
1365
1365
1365
1365
1365
1365
1364
1364
1364
1364
1363
1363
1363
1363
1364

```

**Graph Output
in "CSV"
format
EXCEL file**

Graph, Comma format as seen in Excel

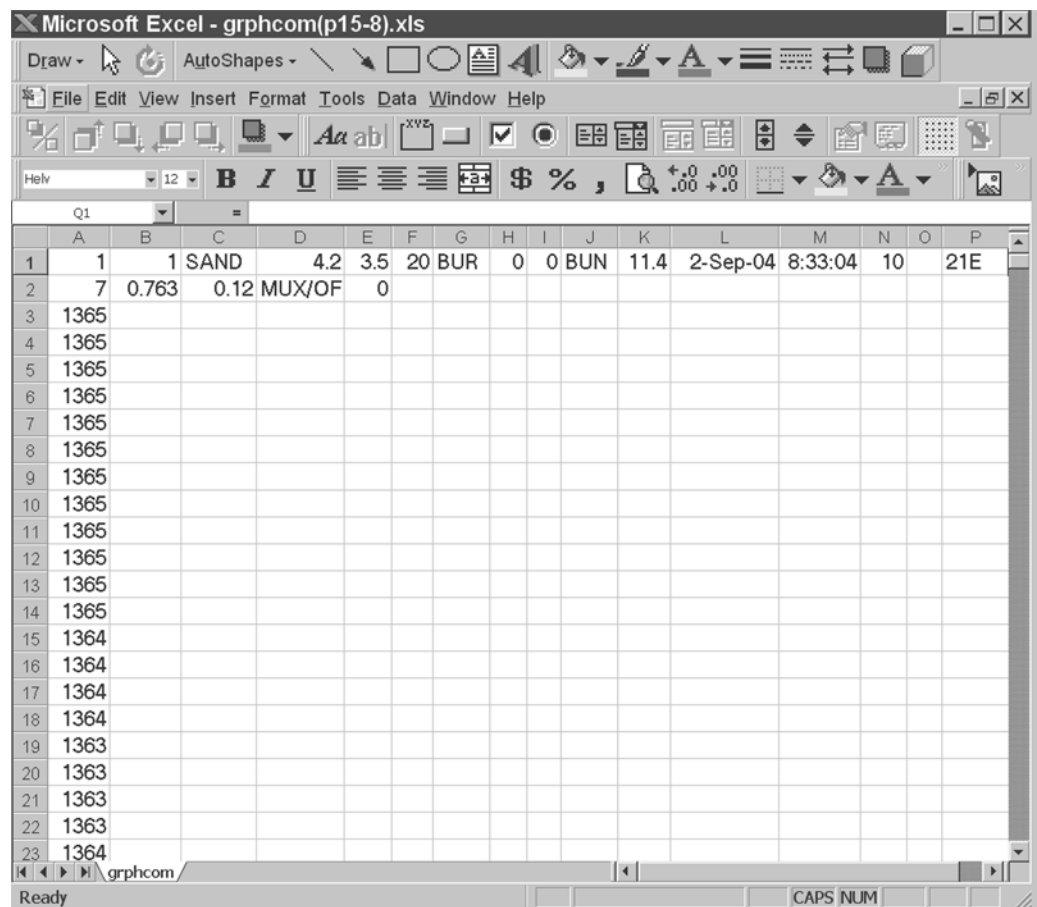

**Readings output
in
1-2-3 format
ASCII file**

Readings sent in 1-2-3 format

```
"Area:",1,"", " 02SEP2004" ,,, " 09:03:14"
,,,, "Waveguide" ,,"MUX" ,," ,," "Zero"
"Area", "No.", "Tag", "%M", "Ka", "cm", "Typ", "G", "Ch", "Tab", "T ns", "Date", "Time", "P", "Message", "Rev"
1,1,"SAND",4.2,3.5,20.0,"BUR",0,0,"BUN",11.4,"02SEP2004","08:33:04",10," ", "21E "
1,2,"SOIL",4.2,3.5,20.0,"BUR",0,0,"BUN",11.3,"02SEP2004","08:34:06",10," ", "21E "
1,3,"SOIL",11.2,6.5,20.0,"BUR",0,0,"BUN",11.0,"02SEP2004","08:34:49",10," ", "21E "
1,4,"SOIL",6.4,4.4,19.0,"CON",0,0,"CUN",13.2,"02SEP2004","08:38:18",10," ", "21E "
1,5,"CLAY",22.8,11.6,19.0,"CON",0,0,"CUN",13.2,"02SEP2004","08:38:58",10," ", "21E "
1,6,"CLAY",38.8,25.1,19.0,"CON",0,0,"CUN",13.2,"02SEP2004","08:39:43",10," ", "21E "
1,7,"SILICA",26.8,14.5,60.0,"CON",0,0,"CUN",13.2,"02SEP2004","08:40:49",10," ", "21E "
1,8,"SILICA",5.3,3.9,60.0,"CON",0,0,"CUN",13.2,"02SEP2004","08:41:31",10," ", "21E "
1,9,"CLAY",34.7,21.0,20.0,"BUR",0,0,"BUN",11.3,"02SEP2004","08:42:32",10," ", "21E "
1,10,"SAND",4.5,3.6,20.0,"BUR",0,0,"BUN",74.1,"02SEP2004","08:44:06",10," ", "21E "
1,11,"SOIL",4.7,3.7,20.0,"BUR",0,0,"BUN",74.0,"02SEP2004","08:45:29",10," ", "21E "
1,12,"SOIL",12.7,7.0,20.0,"BUR",0,0,"BUN",73.7,"02SEP2004","08:46:26",10," ", "21E "
1,13,"CLAY",35.2,21.4,20.0,"BUR",0,0,"BUN",74.0,"02SEP2004","08:47:05",10," ", "21E "
1,14,"SOIL",6.1,4.3,19.0,"CON",0,0,"CUN",76.0,"02SEP2004","08:48:38",10," ", "21E "
```

**Readings
output in
1-2-3 format
Excel file**

Readings, 1-2-3 format, as seen in Excel

Area	No.	Tag	%M	Ka	cm	Typ	G	Ch	Tab	T ns	Date	Time	P	Message	Rev
1	1	SAND	4.2	3.5	20	BUR	0	0	BUN	11.4	2-Sep-04	8:33:04	10		21E
1	2	SOIL	4.2	3.5	20	BUR	0	0	BUN	11.3	2-Sep-04	8:34:06	10		21E
1	3	SOIL	11.2	6.5	20	BUR	0	0	BUN	11	2-Sep-04	8:34:49	10		21E
1	4	SOIL	6.4	4.4	19	CON	0	0	CUN	13.2	2-Sep-04	8:38:18	10		21E
1	5	CLAY	22.8	11.6	19	CON	0	0	CUN	13.2	2-Sep-04	8:38:58	10		21E
1	6	CLAY	38.8	25.1	19	CON	0	0	CUN	13.2	2-Sep-04	8:39:43	10		21E
1	7	SILICA	26.8	14.5	60	CON	0	0	CUN	13.2	2-Sep-04	8:40:49	10		21E
1	8	SILICA	5.3	3.9	60	CON	0	0	CUN	13.2	2-Sep-04	8:41:31	10		21E
1	9	CLAY	34.7	21	20	BUR	0	0	BUN	11.3	2-Sep-04	8:42:32	10		21E
1	10	SAND	4.5	3.6	20	BUR	0	0	BUN	74.1	2-Sep-04	8:44:06	10		21E
1	11	SOIL	4.7	3.7	20	BUR	0	0	BUN	74	2-Sep-04	8:45:29	10		21E
1	12	SOIL	12.7	7	20	BUR	0	0	BUN	73.7	2-Sep-04	8:46:26	10		21E
1	13	CLAY	35.2	21.4	20	BUR	0	0	BUN	74	2-Sep-04	8:47:05	10		21E
1	14	SOIL	6.1	4.3	19	CON	0	0	CUN	76	2-Sep-04	8:48:38	10		21E

Note

When bringing in your .wks file into excel, at the Text Import Wizard Dialogue " box choose DELIMITED under the "Choose the file type that best describes your data". Then go to NEXT> and under "Delimiters" check the "Comma" field, and then FINISH.

**Graph Output
in 1-2-3
Format ASCII
File**

A graph sent in 1-2-3 format

```
1,1,"SAND",3.5,3.3,20.0,"CON",0,0,"BUN",12.7,"25-OCT-95"," 8:36:52",10," ", "20F"  
10.610,0.639,0.140  
1702  
1702  
1702  
1702  
1702  
1702  
1702  
1702  
1702  
1702  
1702  
1702  
1702  
1702  
1702  
1704  
1706  
1709
```

**Graph output
in 1-2-3
Format Excel
File**

Graph, 1-2-3 format, as seen in Excel

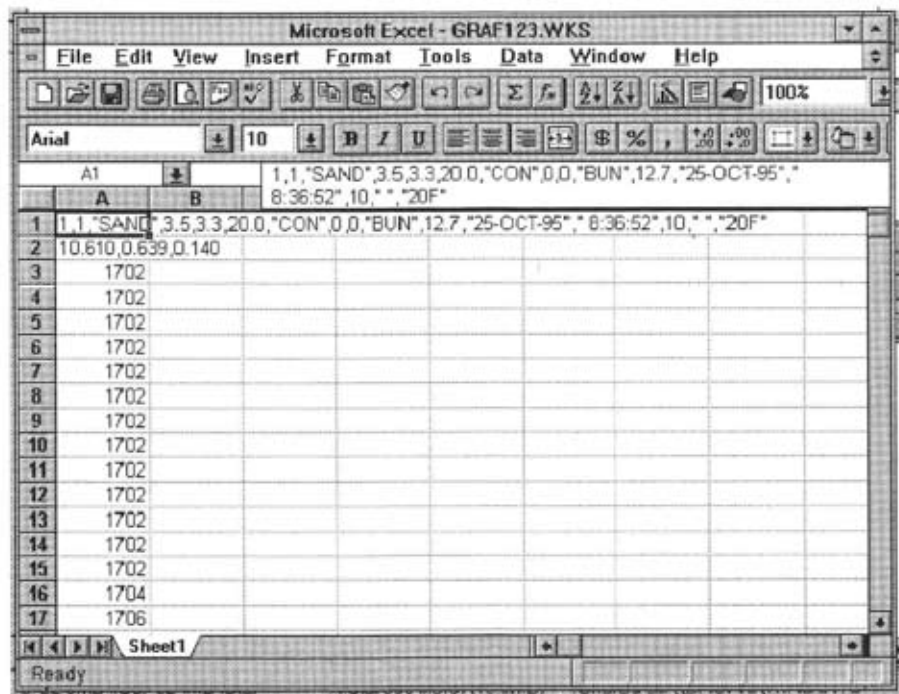

WINTRASE REMOTE CONTROL SOFTWARE FOR DATA COLLECTION AND ANALYSIS

Data Collection from Trase Systems

WinTrase is a comprehensive software program designed for the remote use of Trase via modems, cellular phones, RS232 and RS422 links. The software package is available from Soilmoisture or local Soilmoisture dealers as an accessory to the Trase System I or Trase BE systems. To use the communications and transfer features open WinTrase application, and go to the menu item marked "Remote". Select the baud rate and COM port to be used. If Trase is connected directly and active, WinTrase acknowledges the Trase connection and direct links between the computer and Trase are established. If Trase is located some miles away from your PC and reachable only by modem select the phone icon to establish an indirect link. Once linked you can control and operate Trase remotely including the downloading of any immediate readings taken or those that may have been auto logged over a number of days or weeks. WinTrase downloads all readings/and or graphs into a bulk file for review or analysis. To collect the data simply go to the "Remote" menu item and select "Get Readings" in the "Data Storage Area" you have previously selected.

Display and Analysis of TDR Waveforms Using WinTrase

WinTrase provides a superior method of analysis for either the 1000 pt Trase System TDR waveforms or the 250 pt Tektronix TDR waveforms. Using the same mathematical processes incorporated into Trase, WinTrase can automatically fit tangents to the waveforms, provide movable timebars to adjust transit times, provide multiple custom lookup tables for specialized waveguides and material allowing for quick analysis and determinations.

Data Collection From Trase

```
1,1,"CLAY01",38.8,25.0,19.0,"CON",0,0,"CUN",12.4,"10-OCT-95",
"12:19:45",10,"","20F",""
10.000,1.000,0.000,0.639,0.150
1687
1687
1687
1687
1687
1687
1687
.
```

Data Collection from Tektronix Systems

WinTrase will also work with data collected for Tektronix TDR Metallic Cable Testers 1502 Models having the optional instrument serial ports 070-7324 and waveform capture software. The waveforms captured on a Tektronix TDR unit should be in standard PC format with a .tek extension name to avoid file type confusion.

date: Fri Oct 27 12:25:48 1995 *

notes: *

instr_id: 1502

averages: 1

vertical: 6423

gain: 99.7631 mrho

ddiv: 0.5000 feet

vp: 0.99

cpos: 250

cdist: 13.6200

maxhold: off

pulse: off

singsweep: off

dspohms: off

buttons: 9

waveform: acquired seq: 1

0 0 0 251 14

110 109 109 109 109 109 109 109 109 109 110 110 111 112 112 113 112 111 109

105 100 94 87 80 74 72 70 70 71 73 74 75 76 76 75 74 72

69 66 63 61 58 55 53 51 49 47 46 45 43 42 41 40 40 40

39 39 39 38 38 37 37 37 36 36 36 36 35 35 35 35 35 34

34 34 34 34 33 33 33 33 32 32 32 31 31 31 31 30 30 30...

Imported graph viewed in WinTrase



This is a typical example of an imported graph displayed in Wintrase. You will notice the tangent lines that have been automatically placed using the tangent fit routine available in the application. This and many more features are available to analyze your data using Wintrase. Call your factory or dealer for more information.

16. MULTIPLEXING WITH OPTIONAL MODEL 6022 MULTIPLEXER CONTROL BOARD AND MULTIPLEXER CARDS

If your Trase unit was ordered with the Model 6022 Multiplexer Control Board, or if it has been installed at a later time, your Trase unit has the capability of selectively reading and/or autologging installed Waveguides at many locations.

Each installed Waveguide, together with its connecting cable, is referred to as a "channel". The Model 6020B05 Enclosure, which handles a maximum of 76 channels, and the Model 6020B17 Enclosure, which handles a maximum of 256 channels are used in conjunction with Trase to accomplish the multiplexing operation.

Separate instructions come with the Enclosures showing how the individual Buriable Waveguides are connected to the Switching Boards within the Enclosure, and how the Enclosure is connected up to Trase.

When the Multiplexer Control Board is installed in Trase, there are a number of changes that appear in various screens and there is an additional added screen called the "Multiplexer Screen".

The Measure Screen has an additional selection field and display field as shown.

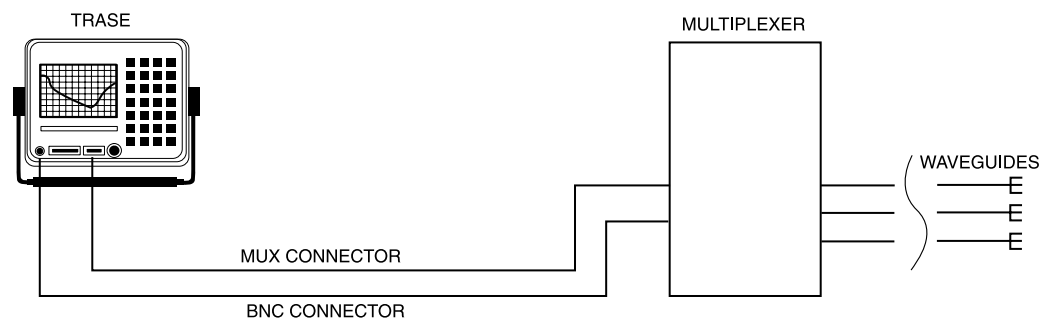
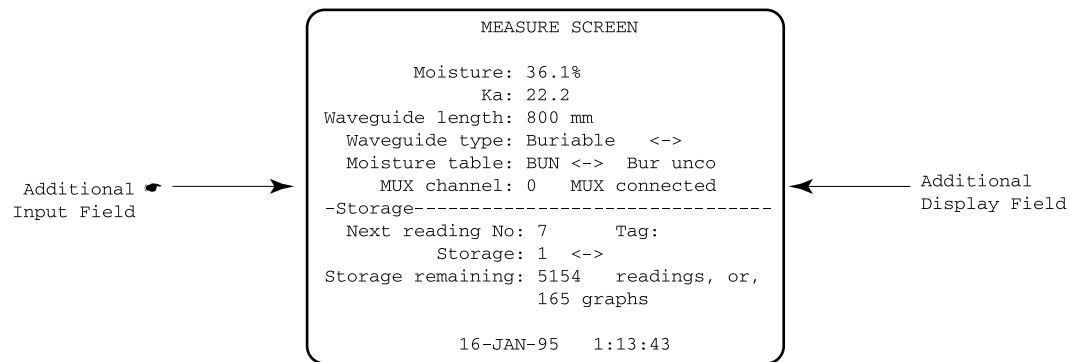

```

AUTOLOG SCREEN

Starting date:          (dd-MMM-yy)
Starting time:         (hh:mm:ss)
Reading interval:      (hh:mm)
Number of cycles: 0    Trap: 0.0 %
Save: Readings        <->
Sequence switch: No   <-> Time: 1.0 secs
Readings will begin on XX-XXX-XXX XX:XX:XX
An autolog cycle will occur every XX:XX
For a total of XXXXXX readings.

NOTE: before autolog begins you must:
+ Set the zero.      + Select the storage.
+ Set WG length.    + Check date & time.
16-JAN-95  1:00:05

```

← Additional Display Field

Note: The number of "X" indicates the size of the Display field

The Autolog Screen has a modified display field as shown.

```

--TDR SCREEN--

MUX channel: XXX MUX connected
Start time: XXX nSec
Range time: 10 nSec <->

After setting Start time and range
press MEASURE to digitize. To see
graph go to Graph screen and select
Reading 0. To save graph go to Measure
screen, tag as desired and press
SAVE GRAPH

23-JAN-95  21:54:51

```

Additional Input Field →

← Additional Display Field

Note: The number of "X" indicates the size of the Input field

The TDR Screen has an additional selection field and display field as shown.

Using The Multiplexer Screen

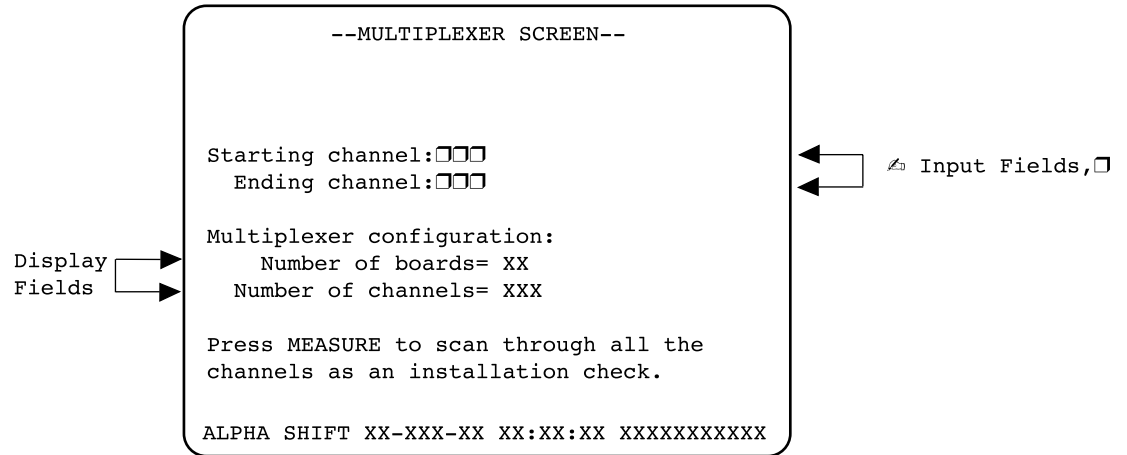

Note: The number of "□" indicates the size of the Input field
The number of "X" indicates the size of the Display field

The Multiplexer Screen provides a place to control the group of channels to be measured during an autologging operation. The Screen also displays the configuration of the boards and channels that have been set up in an associated Enclosure and a means of verifying that interconnections between Trase and the Enclosure are operational.

Call Up Screen

The Multiplexer Screen is available in the "Shift" mode. See "Review the Operational Screens" in Section 5, "Acquaint Yourself with the Operation of the Control Panel". To access the Multiplexer screen first go to the Measure Screen, press the **SHIFT** key, and then press the **NEXT SCREEN** key. The "Autolog Screen" appears. Repeat the process of pressing the **SHIFT** key and then the **NEXT SCREEN** key to cycle through the screens available in the "Shift" mode. The Multiplexer Screen is the third screen in the series between the "TDR Screen" and the "Setup Screen".

Multiplexer Configuration

The "Multiplexer Screen" displays the number of boards that are set up in the Enclosure and the number of channels that are available for use. This is a confirmation of what Trase "detects" and should correspond to what was set up.



As a further check on the installation integrity, you can press the **MEASURE** key while the "Multiplexer Screen" is displayed. When this is done the red "active" light on each of the channels on each of the TDR Switching Boards within the Enclosure will light up in sequence.

Making an Individual Moisture Measurement Through The Multiplex System Using The Measure Screen

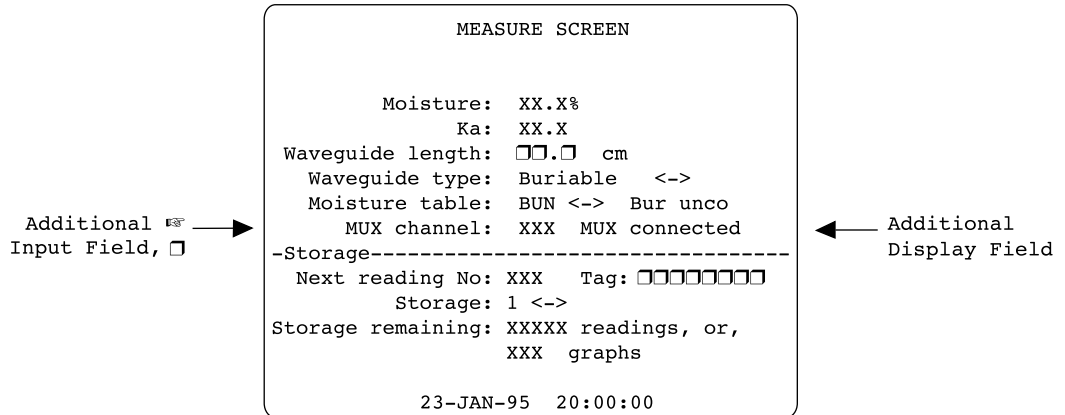
To manually make a moisture measurement of an individual channel (a single Waveguide installation routed through the Multiplex System), key to the “Measure Screen”.

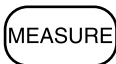

Note: The number of "□" indicates the size of the Input field
The number of "X" indicates the size of the Display field

Press the  key or the  key until the cursor is in the “Mux Channel” input field. Press the numeral key(s) corresponding to the channel number desired and then press the  key and then the  key.

If a standard 20 cm long Model 6005L2 Buriable Waveguide is being used, make sure that “Buriable” is selected in the “Waveguide Type” field, as shown above. Also make sure that the “Waveguide Length” field shows 20.0 cm. See Section 7, on “Using the Measure Screen”, on how to change values in these fields. The procedure for now making and recording the reading and/or graph is the same as covered in Section 7.



In the unusual case where a Model 6002 Waveguide Connector is used in place of the Buriable Waveguide, the procedure is similar to the above, except that the “Connector” must be selected in the “Waveguide Type” field, and it is necessary to “Zero Set” the system and set the waveguide length before making a measurement, as covered in the section, “Using the Measure Screen”, Section 7.

Making An Individual Reading Through The Multiplex System Using The TDR Screen

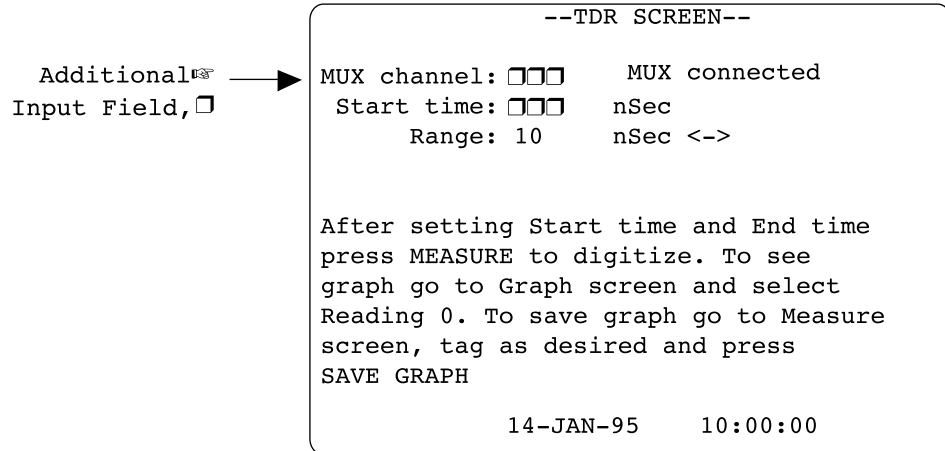
To manually make a reading of an individual channel (a single Waveguide installation routed through the Multiplex System), key to the "TDR Screen".



Note: The number of "□" indicates the size of the Input field
The number of "X" indicates the size of the Display field

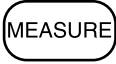

Press the  key or the  key until the cursor is in the "Mux Channel" input field. Press the numeral key corresponding to the channel number desired and then press the  key and then the  key.

All types of measurements, as described in Section 11, "Using the TDR Screen", can now be made through the Multiplex System on the channel selected.

Autologging Through The Multiplex System

The Multiplexer makes it possible to autolog a group of separate Buriable Waveguide installations (channels) in the same manner as a single waveguide installation is autologged as described in Section 10, "Using the Autolog Screen". The group is measured at one time with a 12 second time period between each individual channel measurement.

Selecting Channels to Autolog

If you wish to autolog a group of channels, the "Multiplexer Screen" has provisions for selecting the channels desired. To do so, press the  key or the  key until the cursor is in the "Starting Channel" field. Press the numeral keys desired and then press the  key. Move the cursor to the "Ending channel" field and repeat the process. These will be the range of channels monitored when setting up an autologging cycle.

Setting Up The Autolog Parameters

To set up the various autolog parameters and to initiate the autolog cycle, key to the "Autolog Screen" and follow the detailed instructions in Section 10, "Using the Autolog Screen".

17. MAINTENANCE AND TROUBLESHOOTING

Care And Maintenance

Trase requires very little maintenance other than periodic charging of the batteries.

Clean plastic surfaces with a moist, clean, soft cloth.

The clock setting should be checked every one or two months to verify it is maintaining standard time. If the clock needs resetting, refer to the sections “Set the Date” and “Set the Time” in Section 6, “Using the Setup Screen”.

Troubleshooting

Trase Will Not Turn On When You Press “On/Enter” Key

- 1) Check to see that the main Power Switch is in “on” position and that the Power Cable to Battery Pack is connected. Refer to Section 4, “Requirements Prior to Use.”
- 2) Check Battery Pack to see that batteries are charged and that Overload Reset Switch has not been tripped. Refer to Section 4, “Requirements Prior to Use”.
- 3) If you are using auxiliary power, make sure power cable connections are properly made. Refer to Section 13, “Technical Interface Information”.

Trase Will Not Zero Set

- 1) Is the Waveguide connect handle plugged into Trase?
If it’s a buriable probe, do you have the right waveguide type selected as a “buriable” model?
- 2) Make sure that waveguides have been removed from the connector.
- 3) Be sure Waveguide sockets are not touching any surface, see Section 7, “Using the Measure Screen”.
- 4) Make sure all cable connections are properly made, see Section 3, “Acquaint Yourself with the Parts”.

Unable To Measure Moisture

- 1) Check your entries in the Measure Screen to make sure entries are all properly and completely entered. Refer to section 7, “Using The Measure Screen”.
- 2) Check to make sure plug and cable connections to the Waveguides connector or buried Waveguide are intact. The TDR Screen can be used to check the continuity of connecting cables. Refer to Section 11, “Using the TDR Screen”.
- 3) Check the Capture Window. If you are working with very long Waveguides in very wet soils, the Transit Time through the Waveguides may exceed windowing time of the Capture Window.
You must select a time capture window size of 10ns, 20ns or 40ns, which will encompass the full TDR waveform.
Refer to Section “The Measuring System”, under Section 2, “Principles and Techniques of Operation.”
- 4) If you are working with shorter waveguides or standard buriable waveguides, make sure you are using a 10ns capture window.

Time Measurement Failure

- 1) The Trase Processor can be returned to its initial state. The process is sometimes referred to by the computer industry as a “cold start” or a “cold boot”. *The process erases all stored data and returns all fields to their original default conditions.* This process is normally used only if a computer appears to be malfunctioning in the sequencing of operations or handling of data.
- 2) To initialize the Trase Processor, turn the Power Switch off, wait at least 10 seconds, then turn the Power Switch on. Then, while holding down the “Erase Storage” key, press the “On/Enter” key. The “Initializing Screen” will appear. After you remove your fingers from the keys, press the “On/Enter” key again and the Measure Screen will appear and you can operate normally. After initializing the Processor, you must reset the operational parameters. Refer to Section 6, “Using the Setup Screen”.

Initializing The Trase Processor

- 1) Check the zero set using a connector Waveguide handle without Waveguides.
- 2) If the waveform shows no perceivable end reflection due to high attenuation, you may need coated Waveguides. In high saline conditions, or wet dense fine clays, the attenuation characteristics may require coated Waveguides. As an interim fix, try using shorter waveguides.
- 3) Check the condition of the Waveguide connector cable for damage.
- 4) Check the small right angled SMA connector (at the waveguide connection) to make sure it is tight. **Do not** tighten more than 1/4 turn past finger tight.
- 5) Call your technical representative if you are still having problems.

Accessory Items

See our catalog or World Wide Web site:
<http://www.soilmoisture.com> for more information on:

- 1) **Wintrase, Trase Software for Windows**
- 2) **Trase Firmware upgrades**
- 3) **Special Waveguide designs**
- 4) **Coated Waveguides**
- 5) **Various length Waveguides**
- 6) **Multiplexer Enclosure**
- 7) **Multiplexer switching boards**
- 8) **Multiplexer control boards**
- 9) **Memory expansion cards**
- 10) **Large power packs**
- 11) **Extension cables**

Troubleshooting the Autolog Program With Trap Percentage

Autologging applications are frequently in remote areas and often unattended for periods of time. In the event one obtains what appears to be erratic data, the “trap” feature can be used to investigate the problem.

With the “trap” feature, Trase will automatically store the graph and other diagnostic data associated with a moisture reading that is different from the previous reading for that channel by a percentage difference that has been set in the “trap” input field in the Autolog Screen.

Enter The Trap Percentage

If you have what appears to be erratic readings in your Autolog program, set up the same Autolog program, but first enter the “trap percentage”.

In setting the value of the “trap percentage”, one should consider the maximum percentage change that might be expected between any two subsequent moisture readings. The “trap percentage” should then be set somewhat greater than that value. It is suggested that the “trap percentage” never be set below 5%. Once the “trap percentage” has been entered, the graph and diagnostic data will automatically be saved for any reading that differs from the reading just before it for that channel by more than the “trap percentage” value set.

To set the “trap” percentage, key to the Autolog Screen and then key the cursor to the “trap” input field. Enter the percent desired and press the  key. Then activate the Autolog cycle.

Caution

When the “trap” feature stores the graph and diagnostic data it requires twice as much storage as a graph in memory. For the maximum conservation of memory, you want to trap only those readings that may be in error.

Review Collected Data

Key to the Data Screen and then follow instructions given in Section 8 to isolate the readings with graphs. The graphs can then be called up and viewed on the Graph Screen.

If the graph associated with a given reading is a blank, it would indicate a break in the cable connection to the Waveguide; perhaps an intermittent break that needs attention (See Section 11, “Finding Cable Breaks”).

If the graph does not show a reflection at the end of the Waveguide, you may have exceeded the window size selected. (See Section 2, “The Capture Window” and Section 14, “Moisture Readings Cannot be Made”).



If the graph appears to be normal, but the transit time in the Waveguides measured manually in the Graph Screen does not correspond to the moisture content reported, then the diagnostic data associated with that reading should be downloaded to a printer. A copy of the diagnostic data should then be sent to Soilmoisture Equipment Corp. for analysis.

Manually Determining The Moisture Percentage

The moisture content can be determined manually from the graph (See Section 2, “Theory”; Section 2, “The Measurement System”; Section 9, “Operate the Time Bars”; and Section 2-8, “Relationship of Dielectric Constant, K_a , to Volumetric Water Content of Soils”).

Downloading The Diagnostic Data to Printer or Computer

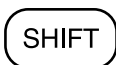
The diagnostic data associated with an individual graph can be downloaded to a printer or computer from the Graph Screen. Cable connections are made in the standard manner as covered in Section 13 under “Sending Individual Graphs”.

After connections are complete, key to the Graph Screen, display the graph desired, and press the  key and then the  key. The moisture reading data will be printed out, followed by the diagnostic data, and then the graph coordinates.

NOTICE:

This instrument is to be used only for the purpose of measuring soil moisture characteristics in adherence to instructions herein. Use of this instrument for any other purpose not specified herein shall make the customer or the customer's assignee wholly liable for any unintended use.

TRASE SYSTEMS, printed circuit boards, software, and instructional information are copyrighted.

© Copyright 1996 Soilmoisture Equipment Corp.
All rights reserved
Pan American International Conference